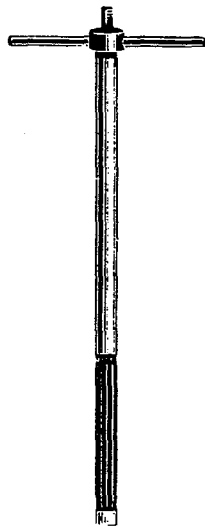
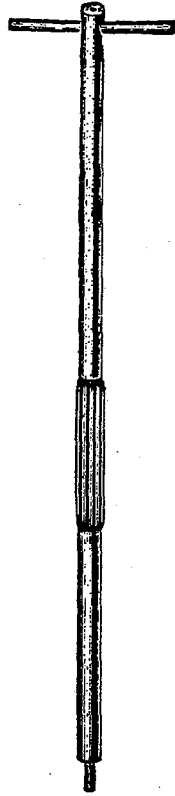

Plate 50- One-fourth Size



Y503
Specify
Size



Y502
Specify
Size

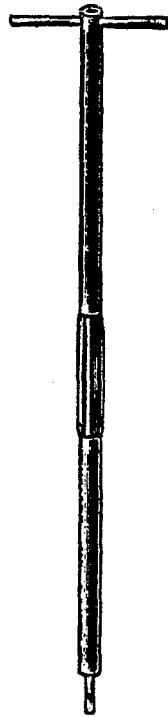

Y500
Specify
Size

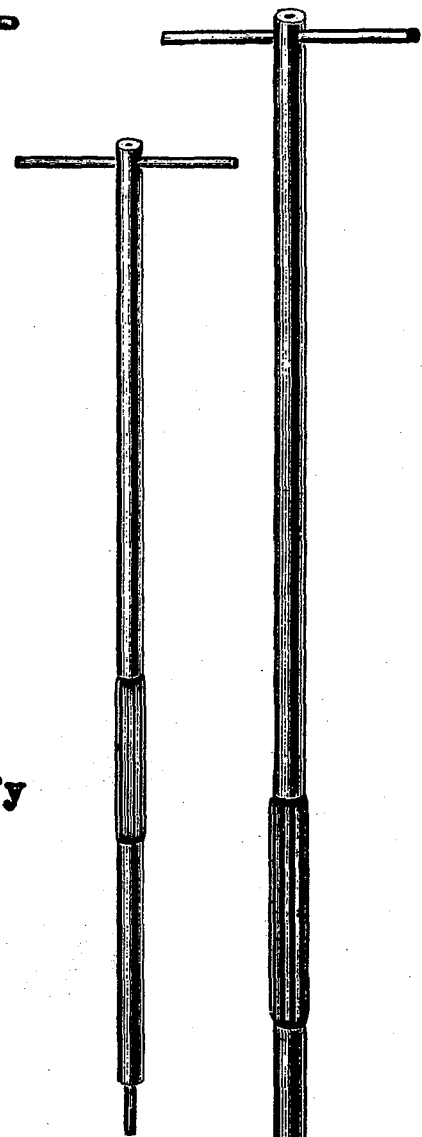

Y505
Specify
Size

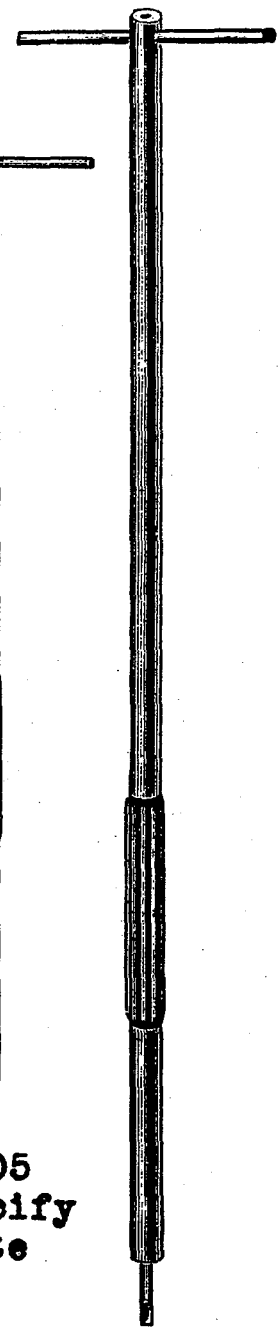

Y 506
Specify
Size

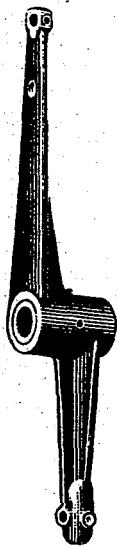

51215A

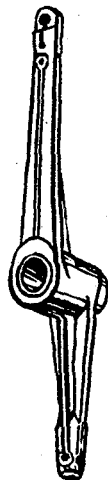

51215B

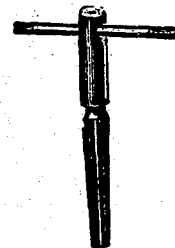

Y802

Plate 51- One-fourth Size

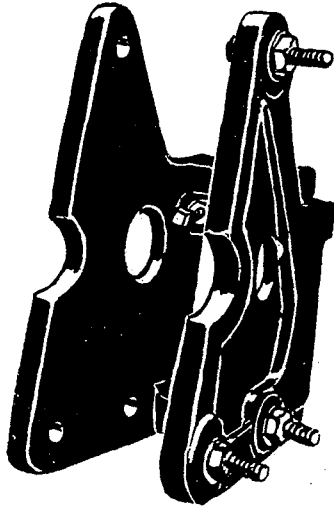

216970

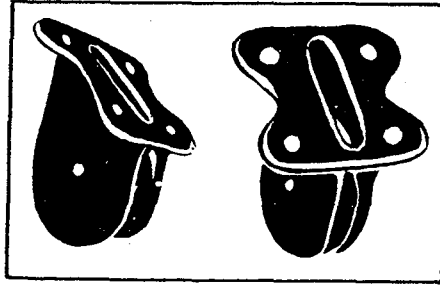

660-159

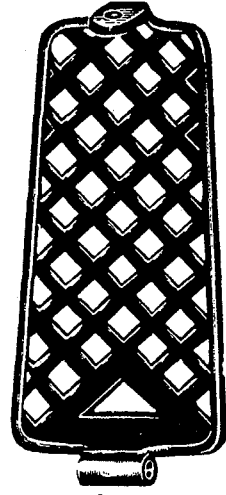

422

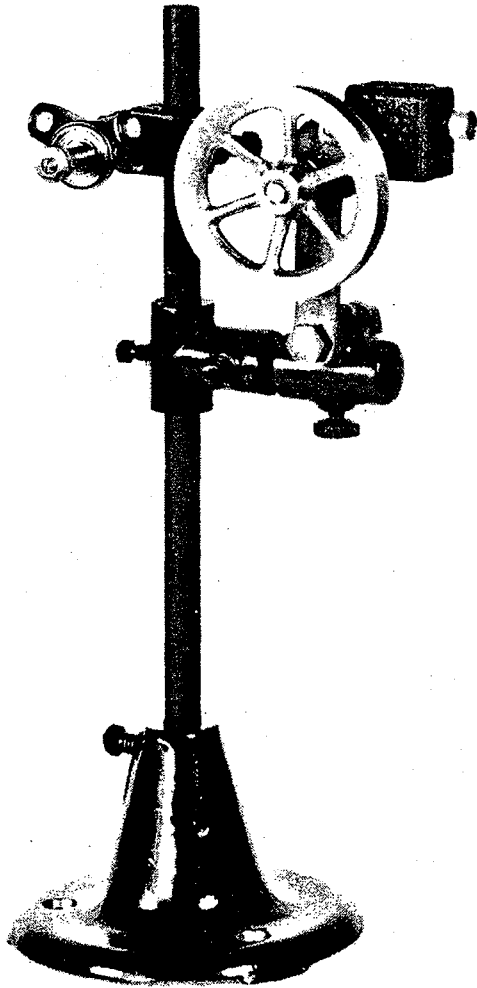

21231 D

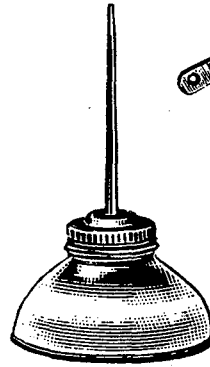

413

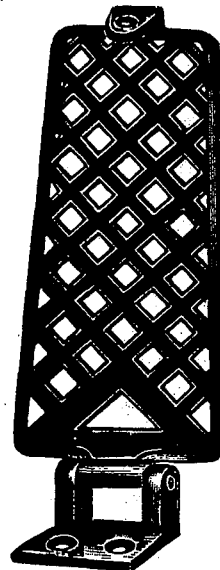

29402

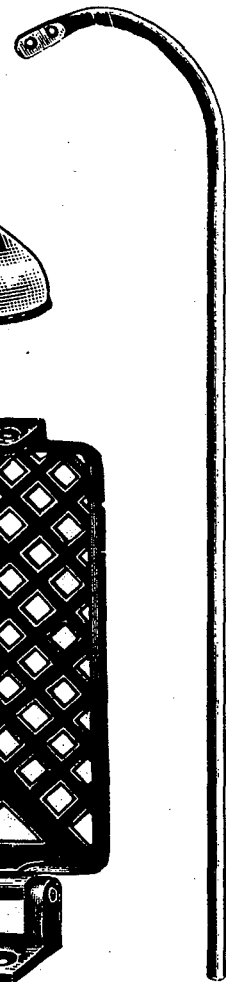

100 B

Plate-52- One-eighth Size

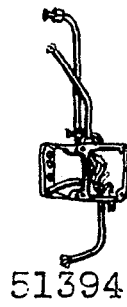

51394

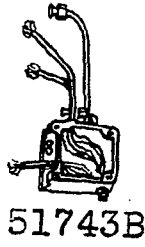

51743B

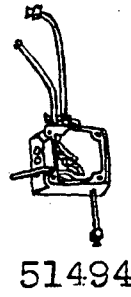

51494

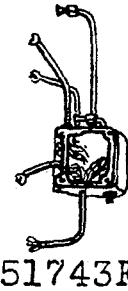

51743F

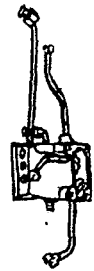

54196A

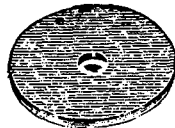

21104F

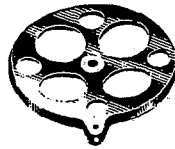

21104D



69 S



21104G



7486P

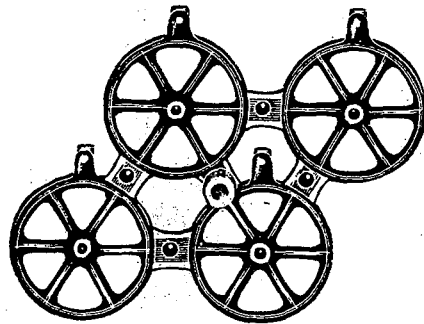

21130A-4

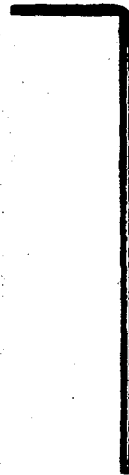

21104K



21104 A

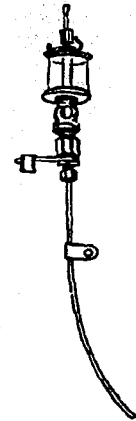

21396C



51283

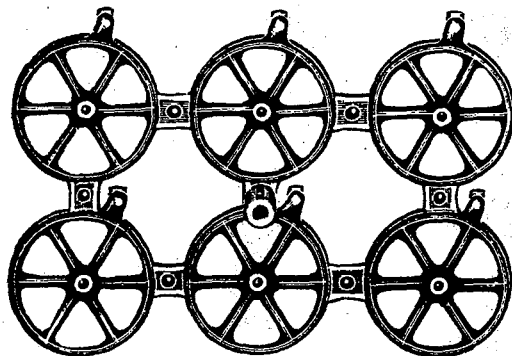

21130A-6

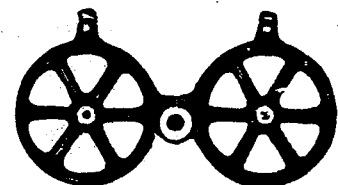

21130 A-2

Plate 53- One-eighth Size

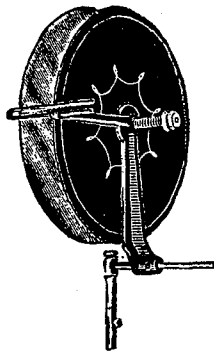

21150A

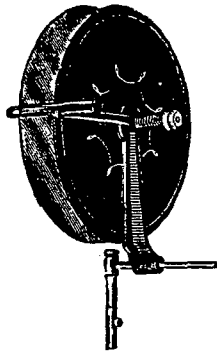

21150 B

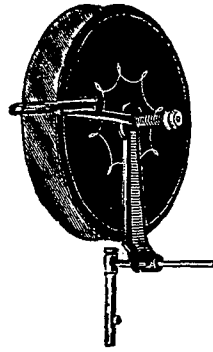

21150 C

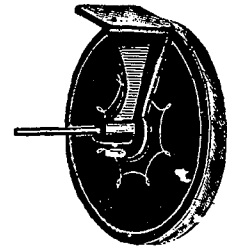

21176A

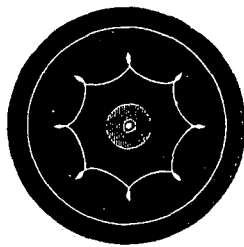

21157

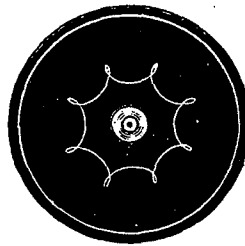

21169E



751

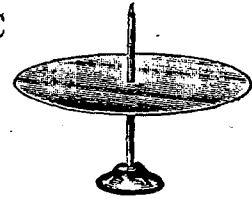

21169D

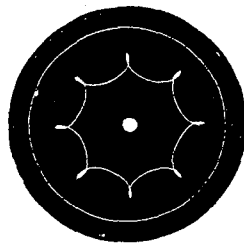

21178



21388 X

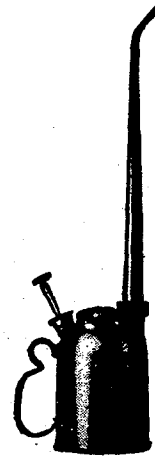

01-19

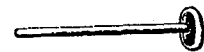

21385B



21169F

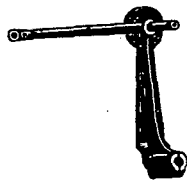

21161C



21161D



21173A



21173B

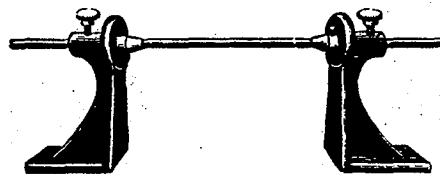

21215



201A

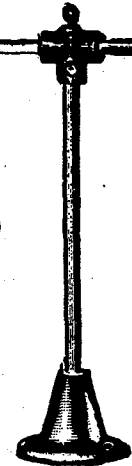

21173C

Plate 54- One-eighth Size

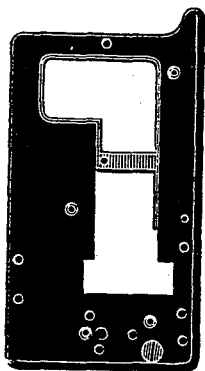

51201

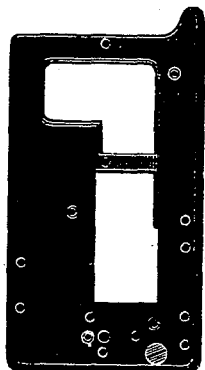

51201A

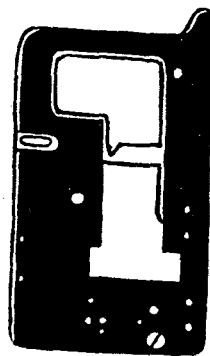

51201B

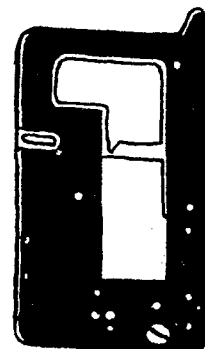

51301A

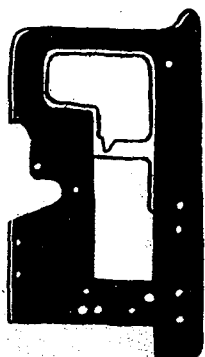

51401H

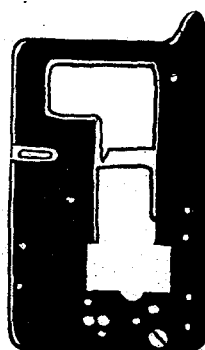

51701C



51401

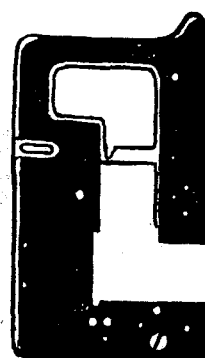

51701F

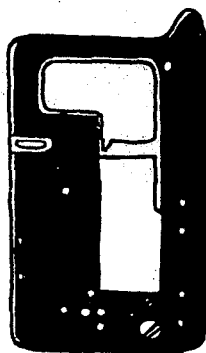

54101



51482B



21375AA

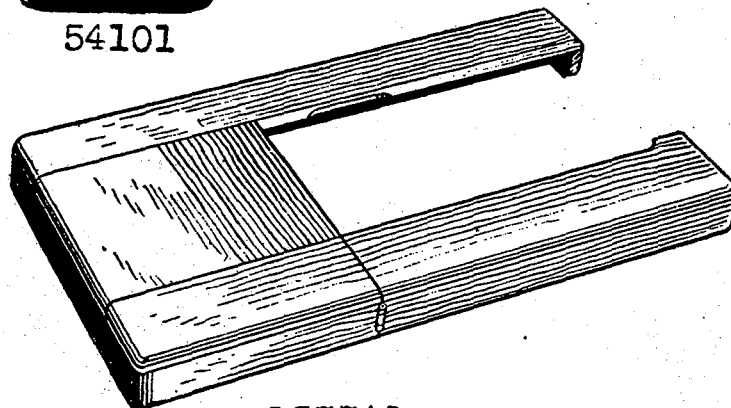

21377AL

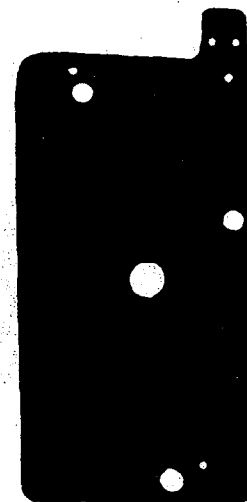

21680AK

Plate 55- One-eighth Size

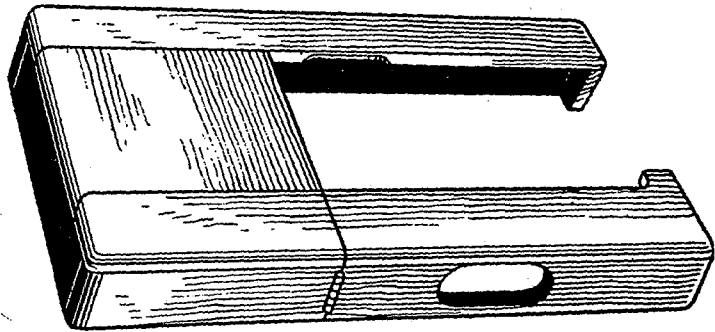

21377AK

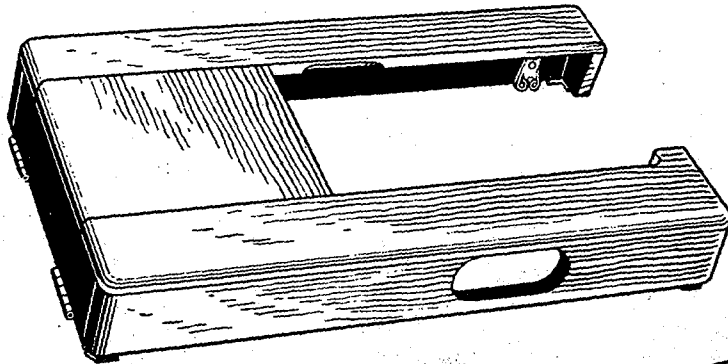

21377AJ

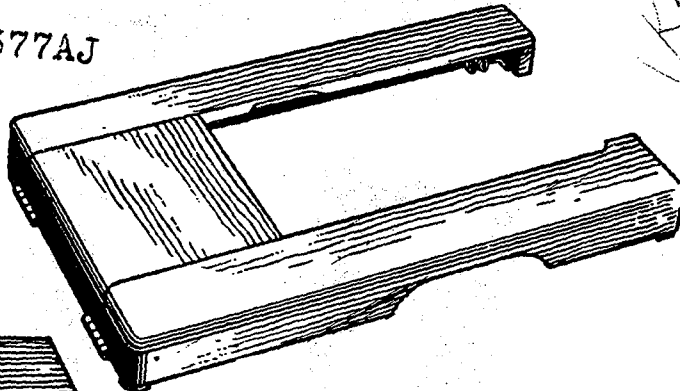

21377AH

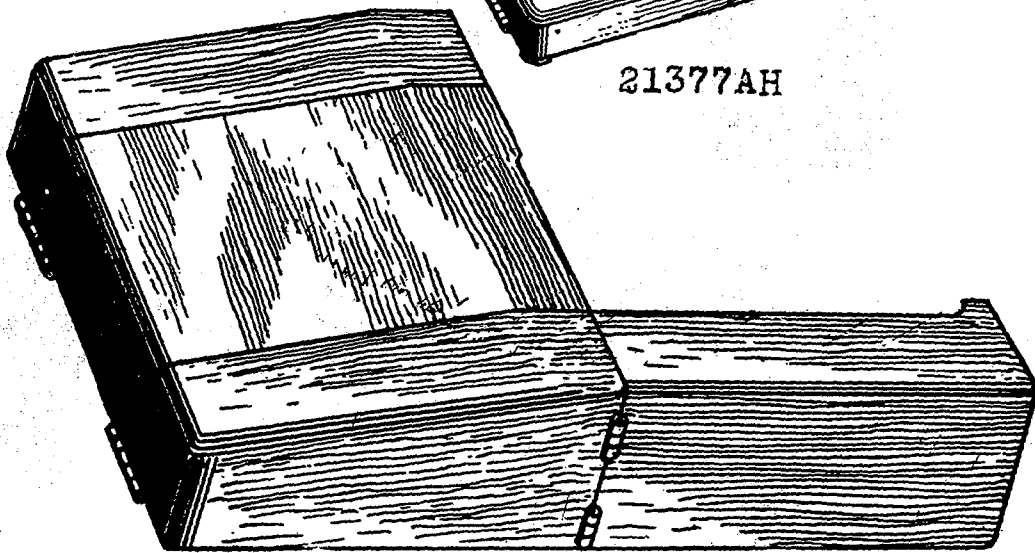

21377AP

Handwritten note: 1/8" dia hole

LIST OF PARTS

Symbol to Order by	The figures in the last column refer only to the plates illustrating the parts and are not to be used in ordering. Refer to pink insert for prices.	Plate No.
T2	Pivot Stud, for collapsible folder connection on Style 51700 F.....	17
WA15	Stop Watch.....	19
16	Feed Crank Link Ferrule.....	28
18	Looper Connecting Rod Nut, right thread.....	19
OI-19	Pressure Pump Oil Can, 1 1/2 pints capacity..	53
20	Feed Crank Stud Washer; also for No. 51758...	20
22 I	Feed Dog, for Style 51200 H (screw No. 22528)	9
T22	Screw, for feed dog on styles in Class 54100.	16
24	Edge Guide, for Styles 51200 H, 51300 A, 51400 K, 51500 C, 51500 G (thumbscrew No. 25).....	33
24 X	Edge Guide, for Style 51200 C (thumbscrew No. 25).....	33
25	Thumbscrew, for cloth plate edge guides.....	18
25 B	Screw, for angular strip guides on Styles 51400 B, 51400 C, 51700 C, 51700 D; also for Nos. 199, 199 A.....	15
25 C	Screw, 9/32 inch long, for cloth plate attachments.....	16
25 S	Screw, for folder clamp; also for Nos. 21163, 23432 A, K48039, 51482 A.....	16
25 T	Thumbscrew, for folder swinging arm; also for Nos. 21172 F, 21172 L.....	17
25 CC	Screw, for folder lever stop on Style 51700 F	15
28	Screw, for lap seam feller upper scrolls; also for Nos. 52804 A, K54381.....	15
28 B	Set Screw, for needle holder thread guide on Styles 51500 C, 51500 G.....	15
28 C	Set Screw, for needles on styles in Class 54100.....	15
36 G	Looper Connecting Rod Ball Stud Washer.....	20
J42 JK	Screw Pin, for presser roller axle support on Style 51400 G.....	17
43	Feed Lift Eccentric, for styles in Classes 51400, 51700, Styles 51200 A, 51200 G, 51200 H, 51900 A; also looper avoid eccentric for styles in Classes 51400, 51700, Styles 51200 A, 51200 G, 51200 H, 51200 J, 51300 A, 51300 C, 51900 A, 51900 B-7 gauge (spot screw No. 96).....	28
43 C	Feed Lift Eccentric, for styles in Classes 51500, 54100, Styles 51200 B, 51200 C, 51200 J, 51300 A, 51300 C, 51900 B, 51900 C; also looper avoid eccentric for Styles 51200 B, 51200 C, 51300 B, 51500 A, 51500 C, 51500 D, 51500 G, 51900 B-8 gauge, 51900 B-9 gauge, 51900 C (spot screw No. 96).....	28

LIST OF PARTS

Symbol to Order by	The figures in the last column refer only to the plates illustrating the parts and are not to be used in ordering. Refer to pink insert for prices.	Plate No.
50 J-16	Needle Stop Pin, for styles in Classes 51400, 51500.....	22
50 J-26	Needle Stop Pin, for styles in Class 51900..	22
52 A	Frame Thread Eyelet, for styles in Classes 51200, 51300, 51500, 54100, Styles 51400 G, 51900 B, 51900 C; also for No. 52894 G (screw No. 98 A and 87 U).....	24
54	Needle Lever Link.....	40
TA54	Hand Tally.....	—
TA55	Hand Tachometer, 4 speed type, 90 to 12000 R.P.M.....	41
56	Needle Clamp Nut, for styles in Classes 51200, 51300.....	19
57 WB	Needle Bar Thread Nipper Plate, for Style 51400 G.....	24
57 WC	Needle Bar Thread Nipper Spring.....	21
57 WD	Needle Bar Thread Nipper Stud; also for No. 9634.....	16
HA61 D	Screw, for puller connecting rod guard on Style 51400 G.....	16
64 A	Presser Spring Regulating Screw, for machines equipped with internal presser spring	18
64 B	Presser Spring Regulating Screw Lock Nut, for machines equipped with internal presser spring.....	19
65 A	Presser Foot, hinged bottom, for Style 51200 H (clamp screw No. 91).....	12
65 XD	Presser Foot Shank, for Styles 51300 B, 51300 D, 51500 D.....	—
69 S	Spool Pin, 4 inches long, for thread stand..	52
69 FD	Screw, square head, cup point, 5/16 inch diameter, 18 threads, 5/8 inch long, for thread stand seat; also for Nos. 21664, 21665.....	18
73	Set Screw, for looper on styles in Classes 51200, 51300, 51400, 51500, 51700, 51900..	15
73 A	Screw, for needle holder thread eyelet; also for Nos. 16194 B, 35830 H.....	15
75 A	Screw, for needle lever connecting rod bearing, lower; also for No. 51243 A.....	17
77	Set Screw, for feed crank link pin; also for Nos. 39135, 51420 C, 51720, 51720 D, 54108 A.....	15
78	Set Screw, for lower needle lever link pin..	15
79	Screw, for take-up eyelet stand on machines equipped with parallel take-up; also for No. 7475 Q.....	16

304-2/-

LIST OF PARTS

Symbol to Order by	The figures in the last column refer only to the plates illustrating the parts and are not to be used in ordering. Refer to pink insert for prices.	Plate No.
80	Screw, for cloth plates; also throat plate support screw for Styles 51200 C, 51200 G, 51200 H, 51200 J, 51300 A, 51300 C, 51300 D, 51400 G, 51400 H, 51400 J, 51500 D, 51700 F, 51700 G, 51700 H, 54100 B, 54100 C, 54100 D, 54100 E.....	16
81	Spot Screw, for puller driving eccentrics, also for No. 41258 D.....	16
86	Stud, for collapsible folder scrolls, also for No. 7487 Q.....	16
86 X	Presser Foot Hinge Stud, for Styles 51300 B, 51300 D, 51500 D, 54100 B, 54100 C, 54100 D, 54100 E.....	16
87	Screw, countersunk head, 1/4 inch long, for throat plates; also for No. 51777 L.....	15
87 A	Screw, countersunk head, for oil reservoir cover..	15
87 B	Screw, countersunk head, 13/64 inch long, for throat plates.....	15
87 U	Screw, for oil reservoir cover thread eyelet; also for Nos. 51260, 51260 A, 51460, 51460 A, 51491, 51960, 51960 A.....	15
88 V	Screw, for looper rocker cone; also for Nos. 161, 198 X , 1287, 1288, 7827 A-6, 16134 K, 21113 B, 21161 D, 21172 J, 21172 K, 51420 L-32, 51774 L, K52524, 52818-8.....	15
88 A	Set Screw, for needle bars.....	15
88 B	Screw, for looper rock shaft sleeves, also needle set screw for Styles 51500 C, 51500 G.....	15
89	Spot Screw, for needle holders; also for Nos. 7486 P, 51461 A, 52883 G.....	15
90	Screw, for louver cover; also for Nos. 23215 BC, 23322 AB, 23322 AC, 23386 H, 23386 J, 23438 B, 23439 A, 51170 B, 51270 A, 51270 B, 52882 B, 53570.....	15
91	Clamp Screw, 3/8 inch long, for presser feet.....	15
91 A	Screw, for presser foot flexible toe on Style 51700 C; also for No. 51430 H.....	15
91 D	Clamp Screw, 7/16 inch long, for presser feet.....	15
93	Clamp Screw, for feed rocker arm; also for Nos. 21375 AH, 51244 B, 51394, 51494, 51743 B, 51743 F, 51774 P, 54196 A.....	16
93 A	Screw, for frame looper thread eyelet on styles in Class 51700; also for Nos. 23324 U, 23324 V, 23401 J, 23401 K, 51959, K53133, K53135.....	16
94	Screw, for looper drive eccentric guard; also for Nos. 539, 7459 A, 51491 B-4, 54139, K54450.....	15
95	Screw, for main shaft collar; also for Nos. 21703 F, 21703 H, 21703 J, 21703 K, 41258 D.....	15

LIST OF PARTS

Symbol to Order by	The figures in the last column refer only to the plates illustrating the parts and are not to be used in ordering. Refer to pink insert for prices.	Plate No.
96	Spot Screw, for feed lift eccentrics and looper drive eccentrics; also for Nos. 51242 C, 51243 P, 51243 Q, 51244, 51343, 51423 B, 51443, 51523 C, 51744, 51744 A, 52840 G.....	15
96 A	Spot Screw, for puller feed roller on Style 51400 G.....	15
97	Screw, for needle lever ball stud guide fork; also for Nos. 51243 C, 51293.....	16
97 A	Screw, for looper drive connection, also for Nos. 51216 A, 51241, 51241 D, 51741, 51741 B..	16
98	Set Screw, 3/16 inch long, without pilot, for needles, also for Nos. 482, 9271, 21161 C, 51235, 51243 P, 51243 Q, 51244, 51343, 51443, 51744, 51744 A, 52840 G.....	15
98 A	Screw, for frame thread eyelets, also for No. 23324 R.....	15
100 B	Thread Stand Wire, 16 inches long (set screw No. 22632 F-24).....	51
107	Strip Tension Ferrule, for Styles 51400 D, 51400 G, 51700 D.....	24
108	Strip Tension Nut, for Styles 51400 D, 51400 G, 51700 D.....	19
109	Tension Disc, with contact surface 5/64 inch wide, for machines using needle threads the equivalent in size of No. 50 and smaller.....	24
109 B	Tension Disc, with contact surface 1/8 inch wide, for machines using needle threads the equivalent in size of No. 40 and larger.....	24
110-3	Tension Spring, .040 inch diameter wire, for tape reel axle, also for Nos. 21182 N, 21182 T.....	21
112	Throat Plate, for Style 51200 H (screw No. 87)..	5
116	Wrench, 9/32 inch opening, for needle clamp nut.	42
116 A	Wrench, 7/32 inch opening, for hexagonal head needle set screws.....	42
118 B	Thread Tweezers.....	42
V118	Tap, marked "X2" for plus size cloth plate screw No. 22521.....	25
134	Stud, for collapsible folder connection link on Style 51700 F.....	16
136	Screw, for facing strip folder bracket on Styles 51400 B, 51400 D, 51700 D.....	17
137	Needle Thread Controller Eyelet, for Styles 51200 A, 51200 G, 51200 H, 51900 B, 51900 C...	24
138	Needle Thread Controller Eyelet Screw.....	15
158 A	Frame Looper Thread Eyelet, with three holes, for styles in Classes 51700, 51900, Styles 51200 A, 51200 G, 51200 H, 51400 G (screw No. 98 A).....	24

LIST OF PARTS

Symbol to Order by	The figures in the last column refer only to the plates illustrating the parts and are not to be used in ordering. Refer to pink insert for prices.	Plate No.
158 B	Frame Looper Thread Eyelet, with two holes, for styles in Classes 51400, 51500, 51700 (screw No. 98 A).....	24
161	Collar, for binding holder disc on Styles 51200 A, 51200 B (screw No. 88).....	20
166	Set Screw, hexagonal head, for feed bar on Style 51400 G.....	15
187 A	Adjusting Screw, for throw-out folder guides; also for Nos. 11534, 23449 C, K49039.....	15
187 B	Screw, for needle holder thread guides.....	15
188 D	Thumb Screw, for elastic band spool support loose cone on Style 51400 G.....	17
195 X	Throat Plate, for Style 51300 D (screw No. 87)..	6
195 Y-6	Throat Plate, for No. 26 gauge Style 51500 D (screw No. 87).....	6
197 X	Feed Dog, for Style 51300 D (screw No. 22528)..	8
197 Y	Feed Dog, for No. 26 gauge Style 51500 D (screw No. 22528).....	8
198 B-6	Presser Foot, for No. 26 gauge Style 51400 J (clamp screw No. 91).....	10
198 X	Presser Foot Assembly, for Style 51300 D; one each Nos. 198 XA, 65 XD, 86 X, 199; two each Nos. 25 B, 88.....	12
198 XA	Presser Foot Bottom, for Style 51300 D.....	—
199	Presser Foot Needle Guard, for Style 51300 D (screw No. 25 B).....	14
199 A	Presser Foot Needle Guard, for Style 51500 D (screw No. 25 B).....	14
201 A	Lower Tape Reel Support, Interlining Support, and Elastic Band Spool Support, for Styles 51400 B, 51400 C, 51400 D, 51400 G, 51700 C, 51700 D, 51700 E.....	53
201 C	Thumbscrew, for lower tape reel axle; also for No. 751.....	18
226	Pivot Screw, for collapsible folder operating rod on Style 51700 F.....	15
243	Cloth Plate End Cover Spring, for Style 51400 G (screw No. 22711).....	38
258 A	Looper Rocker Cone Nut; also for Nos. 35833 A, 51134 G.....	19
269	Looper Connecting Rod Nut, left thread; also for No. 51236 C.....	19
357	Screw, for cloth plate slide spring on Styles 51400 A, 51400 E, 51400 K, 51900 A.....	15
380	Spring, for cloth plate slide on Styles 51400 A, 51400 E, 51400 K, 51900 A (screw No. 357).....	21
402	Collapsible Folder Connection Pivot Stud, upper, for Style 51700 F.....	16

LIST OF PARTS

Symbol to Order by	The figures in the last column refer only to the plates illustrating the parts and are not to be used in ordering. Refer to pink insert for prices.	Plate No.
413	Oil Can, complete.	51
420	Presser Roller Lifter Lever Stud, length over all 1 43/64 inch, for Style 51400 G .	18
420 C	Presser Roller Lifter Lever Stud, length over all 2 5/16 inches, for Style 51400 G (nut No. 11635 B).	18
421	Lifter Lever Chain, 38 inches long	42
421 C-10	Knee Press Chain, 10 inches long	42
422	Lifter Treadle	51
423	Lifter Treadle Base.	42
424	Lifter Treadle Pin (screw No. 22813)	42
426	Collapsible Folder Lever Spring, for Style 51700 F.	21
430 A	Upper Tape Reel Axle, for machines using strips from 1 inch to 1 5/8 inches wide. .	25
430 B	Upper Tape Reel Axle, for machines using strips from 1 1/2 inches to 2 3/8 inches wide	25
430 C	Upper Tape Reel Axle, for machines using strips from 2 1/8 inches to 3 inches wide. .	25
431 A	Upper Tape Reel Spring Latch	30
432	Upper Tape Reel Tension Spring	21
433	Upper Tape Reel Tension Nut, knurled	19
434	Upper Tape Reel Tension Lock Nut	19
482	Feed Rocker Shaft Collar; also looper rock shaft collar, for styles in Class 54100 (set screw No. 98)	35
Y500-257	Expansion Reamer, for needle bar bearings, size .257 inch	50
Y502-319	Expansion Reamer, for upper presser bar bearing, size .319 inch.	50
Y503-319	Expansion Reamer, for lower presser bar bearing, size .319 inch.	50
Y505-407	Expansion Reamer, for looper rocker and feed rocker shaft bearings, size .407 inch. . .	50
Y506-530	Expansion Reamer, for main shaft bearings, size .530 inch	50
531	Set Screw, for presser bar guide and thread controller rack, on Styles 51200 A, 51200 G, 51200 H, 51900 B, 51900 C	15
538	Screw, for supporting feed dogs.	15
539	Frame Thread Eyelet, 2 1/4 inches long, for styles in Class 54100, Style 51500 D (screw No. 94)	30
604	Screw, for intermediate feed gear guard on Style 51700 E; also for Nos. 16241, 51775 A.	15

LIST OF PARTS

Symbol to Order by	The figures in the last column refer only to the plates illustrating the parts and are not to be used in ordering. Refer to pink insert for prices.	Plate No.
605	Screw, for needle stop plate, on Styles 51700 C, 51700 D, 51700 E; also for Nos. 8040, 16194, 16241 A, 35788 B, 52882 D. . .	15
605 A	Screw, for differential feed gear yoke spring; also for Nos. 7933-48, 7933-61, 9735, 16194, 23449 B, 51774 T	15
627	Clamp Screw, for looper driving arm on styles in Class 54100.	17
650-28	Stove Bolt, flat head, 1/4 x 3 1/2 inches . .	—
650-40	Stove Bolt, 1/4 x 5 inches.	—
650 A-16	Stove Bolt, flat head, 5/16 x 2 inches. . . .	—
650 A-18	Stove Bolt, flat head, 5/16 x 2 1/4 inches. . .	—
650 A-20	Stove Bolt, flat head, 5/16 x 2 1/2 inches. . .	—
650 B-26	Stove Bolt, flat head, 3/8 x 3 1/4 inches, for table tops.	—
650 X-18	Carriage Bolt, 5/16 x 2 1/4 inches, for attaching "Electro Drive"	—
650 X-22	Carriage Bolt, 5/16 x 2 3/4 inches, for attaching "Electro Drive"	—
650 X-32	Carriage Bolt, 5/16 x 4 inches, for attaching "Electro Drive"	—
651 D-24	Nut, 3/8 inch, square	—
652-16	Washer, 1/4 inch.	—
652-20	Washer, 5/16 inch	—
652-24	Washer, 3/8 inch.	—
652 C-9	Shake Proof Lock Washer, for needle bar eyelet.	20
660-73	Needle Thread Lubricator Oil Reservoir, for Styles 51300 D, 51500 D	—
660-74	Connection Sleeve, for oil line to main bearing on Styles 51200 A, 51200 G, 51200 H, 51900 B, 51900 C; also for No. 21396 C. . .	29
660-75	Connection Sleeve Coupling; also for No. 21396 C	29
660-81	Oil Drain Extension, for Styles 51300 D, 51500 D, 51700 F, 51700 G, 54100 B, 54100 C	42
660-84	Tube, left, for oil line to main shaft bearing on Styles 51200 A, 51200 G, 51200 H, 51900 B, 51900 C.	37
660-85	Tube, middle, for oil line to main bearings on Styles 51200 A, 51200 G, 51200 H, 51900 B, 51900 C.	37
660-90	Felt Wiper, for looper drive eccentric connection.	29
660-92	Leather Washer, upper, 3/16 inch hole, for main shaft oil gauge; also for No. 39193. .	20
660-93	Leather Washer, lower, 1/4 inch hole, for main shaft oil gauge; also for No. 39193. .	20

LIST OF PARTS

Symbol to Order by	The figures in the last column refer only to the plates illustrating the parts and are not to be used in ordering. Refer to pink insert for prices.	Plate No.
660-94	Glass Tube, for main shaft oil gauge.	37
660-95	Cap, for main shaft oil gauge	29
660-104	Oil Line "T" Coupling, for inner right main shaft bearing on Styles 51200 A, 51200 G, 51200 H, 51900 B, 51900 C	37
660-107	Oil Line Coupling, for left main shaft bear- ing on Styles 51200 A, 51200 G, 51200 H, 51900 B, 51900 C.	29
660-112	Spring and Catch, for trays	14
660-136	Feed Crank Link Oil Tube, for styles in Classes 51200, 51300, 51400, 51500, 51900 .	37
660-138	Feed Crank Link Oil Tube, for styles in Class 54100	37
660-143	Looper Drive Eccentric Oil Tube, for styles in Class 54100.	29
660-148	Isolated Insulator, for table top on line assembly individual power table (plain nut No. 651 D-24, cap nut No. 21371 CT, washer No. 652-24)	42
660-152	Oil Line "T" Coupling, for inner right main shaft bearing on Styles 51200 A, 51200 G, 51200 H, 51900 B, 51900 C	37
660-159	Idle Pulleys, set of two, for leading floor treadle lifter chain away from transmitter or line shaft on American Safety Table installations	51
666-13	Felt Wick, spring pressed, for main shaft bearings.	29
666-16	Reservoir, glass, for oil drain assembly. . .	48
666-19	Felt Wick, for needle lever connecting rod bearing	29
666-28	Oil Cup, for needle lever stud (nut No. 12987 A).	29
666-29	Felt Wick, for needle lever stud.	37
666-49	Glass Tube, for oil level gauge No. 39193 . .	29
666-50	Oil Cup, press fit, for upper oil reservoir cover	29
666-66	Oil Tube, for looper drive eccentric assem- blies on styles in Classes 51300, 51500, 51700, Styles 51200 B, 51200 C, 51200 J, 51400 A, 51400 B, 51400 C, 51400 D, 51400 E, 51400 F, 51400 H, 51400 J, 51400 K, 51400 L, 51400 M, 51400 N, 51900 A	29
666-73	Tube, left, for oil line to main shaft bear- ings on Style 51400 G	37
666-74	Oil Line "T" Coupling, 1 inch long, for oil line to main shaft bearings on Style 51400 G	37
667 D-16	Dowel Pin, 1 inch long, for puller frame on Style 51400 G	—

LIST OF PARTS

Symbol to Order by	The figures in the last column refer only to the plates illustrating the parts and are not to be used in ordering. Refer to pink insert for prices.	Plate No.
668-5	Porcelain Thread Eyelet, 1/4 inch long, for rear take-up thread eyelet on Styles 51200 A, 51200 G, 51200 H.	23
668-6	Porcelain Thread Eyelet, 3/8 inch long, for rear take-up thread eyelet on Styles 51900 B, 51900 C.	23
668-7	Porcelain Thread Eyelet, 5/32 inch long, for tension thread eyelets; also for Nos. 51260, 51460, 51960 A	23
668-12	Porcelain Thread Eyelet Locking Ferrule, for tension thread eyelets.	23
668-13	Porcelain Thread Eyelet Locking Ferrule, for take-up thread eyelets on Styles 51200 A, 51200 G, 51200 H, 51400 G, 51700 C, 51700 D, 51700 E, 51700 F, 51700 G, 51700 H, 51900 B, 51900 C.	23
719	Set Screw, for needle lever stud; also for No. 51250 B	16
751	Elastic Band Spool Support Pin (thumbscrew No. 201 C).	53
753	Elastic Band Spool Support Adjustable Cone (thumbscrew No. 188 D).	30
Y802	Taper Reamer, for needle lever link and feed crank link pins.	50
1096 B	Set Screw, for needle seat block on styles in Class 54100.	15
1248	Feed Crank Link Shim, leather	27
1280	Looper Rocker Stud Nut, for styles in Class 51700	19
1286	Needle Lever Link Pin Assembly; also feed crank link pin assembly; one each Nos. 1286 A, 1286 B, 12964 C, 22560.	25
1286 A	Needle Lever Link Pin (set screw for upper link pin No. 77, clamp screw No. 22864, clamp screw nut No. 51250 C, set screw for lower link pin No. 78).	25
1286 B	Needle Lever Link Pin Spring; also for No. HA1286 (screw No. 22560).	21
HA1286	Presser Roller Fork Pin, for Style 51400 G (screw No. 22560 B)	35
1287	Needle Bar Thread Nipper Assembly, for Style 51400 G; one each Nos. 57 WB, 57 WC, 57 WD, 88, 1288.	24
1288	Needle Bar Thread Nipper Collar (screw No. 88)	24
1332	Collapsible Folder Operating Screw Pin, for Style 51700 F	17
1346	Strip Tension Post, for Styles 51400 D, 51400 G, 51700 D	24

LIST OF PARTS

Symbol to Order by	The figures in the last column refer only to the plates illustrating the parts and are not to be used in ordering. Refer to pink insert for prices.	Plate No.
1349 A-5	Tension Spring, conical, .040 inch diam. wire, for piping strip holder axle on Styles 51700 G, 51700 H	21
1361 A	Presser Spring Pin, for machines equipped with internal presser spring.	27
1740	Presser Foot Yielding Section Plunger Pin, for Styles 51500 C, 51700 E.	—
4761	Looper Connecting Rod, 2 1/16 inches long, for Nos. 112 and 128 gauge styles in Class 51700 (nut, right thread No. 18, nut, left thread No. 269)	25
6042 A	Tilting Feed Dog Holder Washer.	20
6405 M	Feed Dog, for Style 51200 B (screw No. 22528).	8
6405 U	Feed Dog, for Style 51200 J (screw No. 22528).	8
6405 W	Feed Dog, for Style 51200 C (screw No. 22528).	8
6420 W	Presser Foot, for Styles 51200 B, 51200 C (clamp screw No. 91, adjusting screw No. 22840 A, adjusting screw nut No. 51430 F).	12
6424 W	Throat Plate, for Style 51200 C (screw No. 87)	5
6428 L	Throat Plate, for Style 51200 J (screw No. 87)	4
7005 A-4 1/2	Feed Dog, for No. 16 gauge Style 51400 H.	8
7005 A-6	Feed Dog, for No. 18 gauge Style 51400 H.	8
	Feed Dog Screw No. 22528	
7018 E-5	Needle Holder, for No. 18 gauge Styles 51400 G, 51400 H, 51500 A (spot screw No. 89, needle set screw No. 98).	22
7018 E-5 1/2	Needle Holder, for No. 24 gauge Style 51400 G (spot screw No. 89, needle set screw No. 98)	22
7018 E-6	Needle Holder, for No. 26 gauge Styles 51400 J, 51500 D (spot screw No. 89, needle set screw No. 98).	22
7020 B-4 1/2	Presser Foot, for No. 16 gauge Style 51400 H	10
7020 B-5	Presser Foot, for No. 18 gauge Style 51400 H	10
	Presser Foot Clamp Screw No. 91	
7024 C-4 1/2	Throat Plate, for No. 16 gauge Style 51400 H	6
7024 C-5	Throat Plate, for No. 18 gauge Style 51400 H	6
	Throat Plate Screw No. 87	

LIST OF PARTS

Symbol to Order by	The figures in the last column refer only to the plates illustrating the parts and are not to be used in ordering. Refer to pink insert for prices.	Plate No.
7040-6	Thread Guide, detachable, for needle holders on Nos. 18, 24 and 26 gauge Styles 51400 G, 51400 H, 51400 J, 51500 A, 51500 D.	22
7040-48	Thread Guide, detachable, for needle holders on Nos. 56 and 64 gauge styles in Class 51700	22
7040-61	Thread Guide, detachable, for needle holders on Nos. 72, 80 and 88 gauge styles in Class 51700.	22
7403 P	Thread Guide Screw No. 187 B Supplemental Edge Guide, for Style 51400 G (screw No. 25 C)	30
7405 B-6	Feed Dog, for No. 26 gauge Style 51400 J	7
7405 U-4 1/2	Feed Dog, for No. 16 gauge Style 51400 G	7
7405 AF-5 1/2	Feed Dog, for No. 24 gauge Style 51400 G	7
7405 AG-5	Feed Dog, for No. 18 gauge Style 51400 G Feed Dog Screw No. 22528	7
7420 AG-4 1/2	Presser Foot, for No. 16 gauge Style 51400 G.	10
7420 AG-5	Presser Foot, for No. 18 gauge Style 51400 G.	10
7420 AG-5 1/2	Presser Foot, for No. 24 gauge Style 51400 G.	10
	Presser Foot Clamp Screw No. 91	10
7424 B-6	Throat Plate, for No. 26 gauge Style 51400 J.	6
7424 AF-5 1/2	Throat Plate, for No. 24 gauge Style 51400 G.	4
7424 AG-5	Throat Plate, for No. 18 gauge Style 51400 G.	6
	Throat Plate Screw No. 87	
7459 A	Take-up Thread Eyelet Spring, for styles in Class 51700, Styles 51200 A, 51200 G, 51200 H, 51400 G, 51900 B, 51900 C (screw No. 94)	21
7475 Q	Puller Feed Clutch Flange, for Style 51400 G (screw No. 79)	43
7476 P	Lower Puller Roller Shaft, for Style 51400 G.	35
7479 P	Lower Puller Roller Shaft Bushing, 63/64 inch long, for Style 51400 G	26
7481 P	Presser Roller Axle Support, for Style 51400 G (stop pin No. J42 JK).	43
7482 P	Presser Roller Hand Lifter Lever, for Style 51400 G (stud No. 420, set screw No. 92201)	48
7485 P	Puller Connecting Rod Guard, for Style 51400 G (set screw No. HA61 D, attaching screw No. 22517)	43

LIST OF PARTS

Symbol to Order by	The figures in the last column refer only to the plates illustrating the parts and are not to be used in ordering. Refer to pink insert for prices.	Plate No.
7486 P	Presser Roller Lifter Lever, for Style 51400 G (screw No. 89, stud No. 420 C, nut No. 11635 B)	52
7486 PA	Presser Roller Lifter Lever Angle Plate, for Style 51400 G (screw No. 22542)	27
7487 Q	Presser Spring, for puller lifter lever on Style 51400 G (stud No. 86)	44
7489 P	Presser Roller Axle Support Guide Pin, for Style 51400 G	34
7490 P	Puller Feed Roller, for Style 51400 G (spot screw No. 96 A, set screw No. 22597)	43
7491 P	Puller Presser Roller, for Style 51400 G	43
7528 H-4 1/2	Throat Plate, for No. 16 gauge Style 51400 G (screw No. 87)	6
7827 A-6	Presser Foot, for No. 26 gauge Style 51500 D (set screw No. 88, hinge screw No. 86 X, shank No. 65 XD, needle guard No. 199 A, needle guard screws No. 25 B)	12
7933-48	Needle Stop Plate, for Nos. 56 and 64 gauge styles in Class 51700 (screw No. 605 A)	22
7933-61	Needle Stop Plate, for Nos. 72, 80 and 88 gauge styles in Class 51700 (screw No. 605 A)	22
7947	Feed Crank Link Nut; also for No. 51245	19
8040	Presser Foot Yielding Section Spring, for Nos. 64, 72 and 80 gauge Styles 51700 E, 51700 G, 51700 H (screw No. 605)	22
8118-64	Needle Holder, for No. 64 gauge styles in Class 51700 (spot screw No. 89, set screw No. 98)	22
8372 A	Looper Drive Ball Joint Locking Stud Washer, for styles in Classes 51300, 51400, 51500, 51700, Styles 51200 B, 51200 C, 51200 J, 51900 A; also for No. 23448-80.	20
9224 E	Throat Plate, for Styles 51300 A, 51300 C (screw No. 87)	5
9255	Facing Strip Folder Washer, for Styles 51400 B, 51400 D, 51700 D; also for No. 23436	20
9271	Knee Press Shaft Collar (screw No. 98)	35
9634	Yielding Bottom Spring, for Style 51200 G (screw No. 57 WD)	22
9634 A	Yielding Bottom Spring Pin, for Style 51200 G	12

1160

LIST OF PARTS

Symbol to Order by	The figures in the last column refer only to the plates illustrating the parts and are not to be used in ordering. Refer to pink insert for prices.	Plate No.
9705	Feed Dog, for Style 51200 G (screw No. 22528).	9
9720	Presser Foot, for Style 51200 G (clamp screw No. 91, yielding bottom spring stud No. 57 WD, yielding bottom spring No. 9634, yielding bottom spring pin No. 9634 A, yielding section No. 9733, detachable toe No. 9735, detachable toe screw No. 605 A).	12
9724	Throat Plate, for Style 51200 G (screw No. 87)	5
9733	Yielding Section, for presser foot on Style 51200 G.	—
9735	Detachabale Toe, for presser foot on Style 51200 G (screw No. 605 A).	12
9939 F	Looper Rocker Shaft, 7 1/2 inches long, for styles in Class 54100.	48
11534	Yielding Side Spring, for Style 51200 J (screw No. 187 A)	22
11635 B	Nut, for presser roller lifter lever stud on Style 51400 G.	19
11638 M	Main Shaft Oil Gauge Nut; also for No. 21396 C	19
12538	Looper Rocker Ball Stud Nut, for styles in Classes 51200, 51300, 51400, 51500, 51700, 51900.	19
12935 A	Screw, for adjusting presser foot bottom on Style 51900 A.	15
12957 E	Spring Washer, for binder bracket on Style 51200 B; also for Nos. 23184 K, 23437 A, 23449 A.	20
12964 C	Needle Lever Link Pin Ball; also for No. HA1286	19
12982	Lock Nut, for presser roller hand lifter lever regulating screw on Style 51400 G.	19
12986 B	Pivot Stud, for collapsible scroll on Style 51700 F.	16
12987 A	Nut, for needle lever stud oil cup	19
12988 A	Plug Screw, for opening in top of bed on styles in Classes 51300, 51700, 54100; also Styles 51200 B, 51200 C, 51200 J, 51400 A, 51400 B, 51400 C, 51400 D, 51400 E, 51400 F, 51400 H, 51400 J, 51400 K, 51400 L, 51400 M, 51400 N, 51900 A	17
14077	Looper Rocker Ball Stud Nut, for styles in Class 51700.	19
14090	Looper Thread Tension Spring, for Styles 51400 A, 51400 B, 51400 C, 51400 D, 51400 E, 51400 F, 51400 H, 51400 J, 51400 K, 51400 L, 51400 M, 51400 N	21
14786 A	Differential Feed Roll Yoke Support Pin, for Style 51700 E.	35
15430 C	Needle Lever Connecting Rod Nut, left thread, also for No. 21708	19

605

LIST OF PARTS

Symbol to Order by	The figures in the last column refer only to the plates illustrating the parts and are not to be used in ordering. Refer to pink insert for prices.	Plate No.
15430 D	Needle Lever Connecting Rod Nut, right thread; also for No. 21708. .	19
15438 D	Differential Feed Intermediate Gear Stud, for Style 51700 E (nut No. 43443 Q).	16
15465 F	Looper Rocker Cone (screw No. 88, nut No. 258 A).	28
16134 K(12-64-12)	Presser Foot, for No. (12-64-12) gauge styles in Class 54100 (set screw No. 88, hinge stud No. 86 X, yielding section spring No. 16194, yielding section attaching screw No. 605, yielding section adjusting screw No. 605 A).	11
16134 K(16-64-16)	Presser Foot, for No. (16-64-16) gauge styles in Class 54100 (set screw No. 88, hinge stud No. 86 X, yield- ing section spring No. 16194, yielding section attaching screw No. 605, yielding section adjusting screw No. 605 A).	11
16152-56	Needle Holder, for No. 56 gauge styles in Class 51700 (spot screw No. 89, needle set screw No. 98). .	22
16152-72	Needle Holder, for No. 72 gauge styles in Class 51700 (spot screw No. 89, needle set screw No. 98). .	22
16152-80	Needle Holder, for No. 80 gauge styles in Class 51700 (spot screw No. 89, needle set screw No. 98). .	22
16152-88	Needle Holder, for No. 88 gauge styles in Class 51700 (spot screw No. 89, needle set screw No. 22580)	22
16152-96	Needle Holder, for No. 96 gauge styles in Class 51700 (spot screw No. 89, needle set screw No. 98). .	22
16152-112	Needle Holder, for No. 112 gauge styles in Class 51700 (spot screw No. 89, needle set screw No. 98). .	22
16152-128 ✓	Needle Holder, for No. 128 gauge styles in Class 51700 (spot screw No. 89, needle set screw No. 98). .	22
16154(12-64-12)	Needle Holder, for No. (12-64-12) gauge styles in Class 54100 (spot screw No. 89)	38
16154(16-64-16)	Needle Holder, for No. (16-64-16) gauge styles in Class 54100 (spot screw No. 89)	38

LIST OF PARTS

Symbol to Order by	The figures in the last column refer only to the plates illustrating the parts and are not to be used in ordering. Refer to pink insert for prices.	Plate No.
16164	Tension Post Ferrule, for strip tensions on Styles 51400 D, 51400 G, 51700 D	24
16182 B	Needle Stop Plate, for No. 96 gauge styles in Class 51700 (screw No. 605).	38
16182 C	Needle Stop Plate, for Nos. 112 and 128 gauge styles in Class 51700 (screw No. 605).	38
16184 A-4(12-64-12)	Needle Seat Block, for No. (12-64-12) gauge styles in Class 54100 (set screw No. 1096 B) . .	38
16184 A-4(16-64-16)	Needle Seat Block, for No. (16-64-16) gauge styles in Class 54100 (set screw No. 1096 B). .	38
16194	Presser Foot Yielding Section Spring, for Styles 51400 M, 51700 F, 51700 G, 51700 H, 54100 B, 54100 C, 54100 D, 54100 E (attaching screw No. 605, adjusting screw No. 605 A) . . .	22
16194 B	Presser Foot Strip Guide, for Styles 51700 G, 51700 H (screw No. 73 A).	12
16197-2-16	Needle Holder Thread Eyelet, for styles in Class 54100 (screw No. 73 A	24
16241	Spring, for tilting right section of presser foot on Style 51700 F (screw No. 604).	22
16241 A	Spring, for tilting left section of presser foot on Style 51700 F (screw No. 605).	22
16505-88	Feed Dog, for No. 88 gauge Style 51700 F (screw No. 22528).	9
16524 B-88	Throat Plate, for No. 88 gauge Style 51700 F (screw No. 87) . .	6
16527 B-88	Presser Foot, for No. 88 gauge Style 51700 F (set screws No. 22570, yielding section spring No. 16194, yielding section spring attaching screw No. 605, yielding section spring adjusting screw No. 605 A, right section tilting spring No. 16241, right section tilting spring screw No. 604, left section tilting spring No. 16241 A, left section tilting spring screw No. 605)	11

LIST OF PARTS

Symbol to Order by	The figures in the last column refer only to the plates illustrating the parts and are not to be used in ordering. Refer to pink insert for prices.	Plate No.
16638 D	Elastic Guide Spring, for Style 51400 G . . .	21
21104 A	Thread Stand Base; also upper tape reel support base (screw No. 22509).	52
21104 B-2	Piping Cord Stand Rod, 2 inches long, for Styles 51700 G, 51700 H	48
21104 B-11	Thread Stand Rod, 11 inches long; also upper tape reel support rod and piping cord stand rod.	48
21104 B-14	Upper Tape Reel Support Rod, 14 inches long, for Styles 51700 G, 51700 H	48
21104 B-20	Upper Tape Reel Support Rod, 20 inches long, for styles in Classes 51700	48
21104 C	Piping Cord Stand Rod Connection, for Styles 51700 G, 51700 H (screw No. 22509)	41
21104 D	Piping Cord Spool Seat, for Styles 51700 G, 51700 H	52
21104 E	Piping Cord Spool Seat Connection, for Styles 51700 G, 51700 H	41
21104 F	Piping Cord Spool Seat Pad, for Styles 51700 G, 51700 H.	52
21104 G	Piping Cord Spool Pin, for Styles 51700 G, 51700 H	52
21104 H	Piping Cord Spool Pin Nut, for Styles 51700 G, 51700 H.	19
21104 K	Piping Cord Guide Wire, for Styles 51700 G, 51700 H (screw No. 22632 F-24).	52
21105 J	Piping Cord Stand Cord Guide, for Styles 51700 G, 51700 H.	24
21113 A	Thread Stand Wire Extension, 6 inches long (set screw No. 22632 F-24).	35
21113 B	Thread Stand Wire Coupling (screw No. 88) .	24
21130 A-2	Thread Stand Seat, 2 spools	52
21130 A-4	Thread Stand Seat, 4 spools	52
21130 A-6	Thread Stand Seat, 6 spools	52
21145	Thread Stand Seat Set Screw No. 69 FD	
21150 A	Cone, wood, for thread stand.	42
	Upper Tape Reel Assembly, for machines using strips 1 inch to 1 5/8 inches wide, one each Nos. 430 A, 25 S, 88, 94, 431 A, 432, 433, 434, 21161 C, 21161 D, 21163, 21164 and two each Nos. 98, 21157. Specify component parts in ordering	53
21150 B	Upper Tape Reel Assembly, for machines using strips 1 1/2 inches to 2 3/8 inches wide; one each Nos. 430 B, 25 S, 88, 94, 431 A, 432, 433, 434, 21161 C, 21161 D, 21163, 21164 and two each Nos. 98, 21157. Specify component parts in ordering	53

LIST OF PARTS

Symbol to Order by	The figures in the last column refer only to the plates illustrating the parts and are not to be used in ordering. Refer to pink insert for prices.	Plate No.
21150 C	Upper Tape Reel Assembly, for machines using strips 2 1/8 inches to 3 inches wide; one each Nos. 430 C, 25 S, 88, 94, 431 A, 432, 433, 434, 21161 C, 21161 D, 21163, 21164 and two each Nos. 98, 21157. Specify component parts in ordering	53
21157	Upper Tape Reel Disc, 8 inches diameter.	53
21161 C	Upper Tape Reel Frame (set screw No. 98)	53
21161 D	Upper Tape Reel Strip Guide (set screw No. 88)	53
21163	Upper Tape Reel Horizontal Rod, 4 5/16 inches long (set screw No. 25 S).	35
21164	Upper Tape Reel Post (set screw No. 22508)	34
21169 D	Binding Holder Assembly, for Styles 51200 A, 51200 B, one each Nos. 21169 E, 21169 F, 88, 161. Specify component parts in ordering.	53
21169 E	Binding Holder Disc.	53
21169 F	Binding Holder Base.	53
21172 E	Piping Strip Holder Disc, right, for Styles 51700 G, 51700 H	—
21172 F	Piping Strip Holder Disc, left, for Styles 51700 G, 51700 H (thumb screw No. 25 T).	—
21172 J	Piping Strip Guide and Tension, for Styles 51700 G, 51700 H (set screw No. 88).	—
21172 K	Piping Strip Guide and Tension Support, for Styles 51700 G, 51700 H (set screw No. 88)	—
21172 L	Piping Strip Disc Tension Spring Hub, for Styles 51700 G, 51700 H (thumb screw No. 25 T).	—
21172 M	Piping Strip Disc Supporting Rod Holder, for Styles 51700 G, 51700 H.	—
21172 N	Piping Strip Holder Disc Axle, for Styles 51700 G, 51700 H	—
21173 A	Vertical Rod Connection, for upper tape reel support (screw No. 22507).	53
21173 B	Horizontal Rod Connection, for upper tape reel support (screw No. 22508).	53
21173 C	Upper Tape Reel Support Assembly, for attaching long length center plaits to shirts on Styles 51400 B, 51400 C, 51700 C, 51700 D; one each Nos. 21104 A, 21104 B-11, 21104 B-20, 21173 A, 21173 B; two No. 22509, four No. 22508. Specify component parts in ordering	53
21176 A	Lower Tape Holder, complete, for Styles 51400 B, 51400 C, 51400 D, 51700 C, 51700 D, 51700 E; one each Nos. 110-3, 201 A, 201 C, 21385 B and two No. 21178. Specify component parts in ordering	53

LIST OF PARTS

Symbol to Order by	The figures in the last column refer only to the plates illustrating the parts and are not to be used in ordering. Refer to pink insert for prices.	Plate No.
21178	Tape Reel Disc, 8 inches diameter, for Styles 51400 B, 51400 C, 51400 D, 51700 C, 51700 D, 51700 E, 51700 G, 51700 H.	53
21182 K	Strip Tension Plate, outer, for Styles 51400 D, 51400 G, 51700 D.	—
21182 L	Strip Tension Plate, inner, for Styles 51400 D, 51700 D.	—
21182 N	Strip Tension Assembly, for Styles 51400 D, 51700 D, one each Nos. 21182 K, 21182 L, 21182 P and two each Nos. 107, 108, 110-3, 1346, 16164.	33
21182 P	Strip Tension Base, for Styles 51400 D, 51400 G, 51700 D.	—
21182 T	Strip Tension Assembly, for Style 51400 G, one each Nos. 21182 K, 21182 P and two each Nos. 107, 108, 110-3, 1346, 16164.	33
21192 R	Steel Ball, for opening in main oil reservoir on Styles 51700 F, 51700 G, 54100 B, 54100 C.	19
21201	Screw Driver, 9/64 inch round blade, length overall 7 5/8 inches.	49
21202	Screw Driver, 7/32 inch round blade, length overall 11 1/4 inches.	49
21203	Screw Driver, 13/64 inch round blade, length overall 15 1/2 inches.	49
21204	Screw Driver, 9/32 inch round blade, length overall 15 inches.	49
21205 A	Screw Driver, 3/8 inch round blade, length overall 14 inches.	49
21207	Screw Driver, 7/64 inch round blade, length overall 2 1/2 inches.	42
21208	Screw Driver Set, three detachable blades.	49
21210	Looper Collar, .040 inch thick.	20
21210 A	Looper Collar, .020 inch thick.	20
21211	Looper Collar, .054 inch thick.	20
21215	Elastic Band Spool Support Assembly, for Style 51400 G, one each Nos. 188 D, 753, 21218, two each Nos. 201 A, 201 C, 751 A. Specify component parts in ordering.	53
21218	Elastic Band Spool Support Axle, 10 inches long.	35
21225-1/8	Looper Adjusting Gauge, 1/8 inch measurement.	19
21225-5/32	Looper Adjusting Gauge, 5/32 inch measurement.	19

LIST OF PARTS

Symbol to Order by	The figures in the last column refer only to the plates illustrating the parts and are not to be used in ordering. Refer to pink insert for prices.	Plate No.
21227 R	Gauge, for synchronizing looper and needle motions on styles in Classes 51200, 51300, 51400, 51500, 51700, and 51900 equipped with throat plates 2 1/4 inches long, component parts are shipped in leather case	41
21227 AC	Gauge, for synchronizing looper and needle motions on styles in Classes 51200, 51300, 51400, 51500, 51700 and 51900 equipped with throat plates 3 1/8 inches long, component parts are shipped in leather case	41
21227 HH	Porcelain Eyelet Replacement Tool Set, for assembling 1/16 inch internal diameter porcelain eyelet No. 668-7 and aluminum ferrule No. 668-12 in tension thread eyelet assembly. Ferrule should always be replaced.	41
21231 D	Thread Meter, for recording the consumption of thread in 1/10 yards as it passes into the sewing machine	51
21233 D	Light Fixture Assembly, including bulb, table mounting, for machines driven by "Electro Drive".	—
21236	Belt Plier, for 3/8 inch and smaller round belting.	49
21260	Emery Cord, 3/64 inch diameter, grade No. 120, fifty yard spool.	—
21260 A	Emery Cord, 3/64 inch diameter, grade No. 150, fifty yard spool.	—
21260 B	Emery Cord, 1/32 inch diameter, grade No. 180, fifty yard spool.	—
21260 C	Emery Cord, .025 inch diameter, grade No. 200, fifty yard spool.	—
21260 D	Emery Tape, 3/32 inch wide, grade No. 180, fifty yard spool	—
21260 E	Emery Cord, .018 inch diameter, grade No. 200, fifty yard spool.	—
21261	Leather Belt, flat, 1 inch wide, 63 inches long, includes belt fastener No. 21350	—
21262	Leather Belt, round, 9/32 inch diameter, 44 inches long, includes wire belt hook No. 21351.	—
21262 G-340	"V" Belt, No. 2 size, 34 inches outside circumference.	49
21262 G-350	"V" Belt, 35 inches outside circumference.	49
21262 G-370	"V" Belt, 37 inches outside circumference.	49
21262 G-380	"V" Belt, 38 inches outside circumference.	49

LIST OF PARTS

Symbol to Order by	The figures in the last column refer only to the plates illustrating the parts and are not to be used in ordering. Refer to pink insert for prices.	Plate No.
21300 C-5 3/4	Carriage Bolt, countersunk head, 3/8 x 5 3/4 inches, for table tops	—
21350	Belt Fastener, malleable iron, for 1 inch flat belt	29
21351	Belt Hook, wire, for 9/32 inch round belt	29
21355	Chair Leg Extension, 4 inches long	42
21371 Q	Table Drawer	—
21371 BR-42	Table Top, 42" x 16" x 1 3/4", prepared completely for group semisubmerged isolated installation of styles in Classes 51200, 51300, 51400, 51500, 51700, 51900 without puller.	—
21371 BR-48	Table Top, 48" long.	—
21371 BR-54	Table Top, 54" long.	—
21371 BR-60	Table Top, 60" long.	—
21371 BS-48	Table Top, 48" x 16" x 1 3/4", prepared completely for group full submerged isolated installation of styles in Classes 51200, 51300, 51400, 51500, 51700, 51900 without puller.	—
21371 BS-54	Table Top, 54" long.	—
21371 BS-60	Table Top, 60" long.	—
21371 BT-42	Blank Table Top, 42" x 16" x 1 3/4", for nonsubmerged group installation of all machines	—
21371 BT-48	Blank Table Top, 48" long.	—
21371 BT-54	Blank Table Top, 54" long.	—
21371 BT-60	Blank Table Top, 60" long.	—
21371 CT	Cap Nut, for isolated insulator on line assembly individual power table.	19
21371 CX-48	Table Top, 48" x 16" x 1 3/4", includes base plate No. 21680 AK, for nonsubmerged isolated installation of Style 51400 G.	—
21371 CX-54	Table Top, 54" long.	—
21371 CX-60	Table Top, 60" long.	—
21371 FQ-42	Table Top, 42" x 16" x 1 3/4" for line assembly nonsubmerged isolated installations of styles in Classes 51200, 51300, 51400, 51500, 51700, 51900, 54100 without puller.	—
21371 FQ-48	Table Top, 48 inches long.	—
21371 FQ-54	Table Top, 54 inches long.	—
21371 FQ-60	Table Top, 60 inches long.	—
21371 FR-42	Table Top, 42" x 16" x 1 3/4", for line assembly semisubmerged isolated installations of styles in Classes 51200, 51300, 51400, 51500, 51700, 51900, 54100 without puller.	—

LIST OF PARTS

Symbol to Order by	The figures in the last column refer only to the plates illustrating the parts and are not to be used in ordering. Refer to pink insert for prices.	Plate No.
21371 FR-48	Table Top, 48 inches long.	—
21371 FR-54	" " 54 inches long.	—
21371 FR-60	" " 60 inches long.	—
21371 GT-48	Table Top, 48" x 19" x 1 3/4", prepared completely for group semisubmerged iso- lated installation of styles in Classes 51200, 51300, 51400, 51500, 51700, 51900, 54100 equipped with Class 21700 puller	—
21373 A-5	General Utility Individual Power Table, for nonsubmerged installations of mach- ines without puller, equipped with "Electro Drive", 1/2 H.P., A.C. 1 phase, 60 cycles, 105-115 volts, 3400 R.P.M.	—
21373 A-5D	For 1/2 H.P., A.C., 1 phase, 60 cycles, 220 volts, 3450 R.P.M.	—
21373 A-7	For 1/2 H.P., A.C., 3 phase, 60 cycles, 105-115 volts, 3500 R.P.M.	—
21373 A-7B	For 1/2 H.P., A.C., 3 phase, 60 cycles, 210-230 volts, 3500 R.P.M.	—
21373 A-7D	For 1/2 H.P., A.C., 3 phase, 60 cycles, 440 volts, 3500 R.P.M.	—
21373 A-8	For 1/2 H.P., D.C., 105-115 volts, 3000 R.P.M.	—
21373 A-8A	For 1/2 H.P., D.C., 210-230 volts, 3000 R.P.M.	—
21375 AA	Pulley Guard, table mounting	54
21375 AH	Pulley Guard, machine mounting (screw No. 93).	47
21377 AH	Tray, 2 9/32" high, hinged body, for semi- submerged isolated installations of styles in Classes 51200, 51300, 51400, 51500, 51700, 51900 without puller or attachments overhanging the front of the cloth plate and are equipped with parallel take-up	55
21377 AJ	Tray, 4 1/32" high, hinged body, for non- submerged isolated installations of styles in Classes 51200, 51300, 51400, 51500, 51700, 51900 without puller or attachments overhanging the front of the cloth plate and are equipped with parallel take-up	55

LIST OF PARTS

Symbol to Order by	The figures in the last column refer only to the plates illustrating the parts and are not to be used in ordering. Refer to pink insert for prices.	Plate No.
21377 AK	Tray, 4 1/32" high, hinged body and front section, for nonsubmerged isolated installations of styles in Classes 51200, 51300, 51400, 51500, 51700, 51900, without puller and equipped with attachments overhanging the front of the cloth plate. . . .	55
21377 AL	Tray, 2 9/32" high, hinged body and front section, for semisubmerged isolated installations of styles in Classes 51200, 51300, 51400, 51500, 51700, 51900, 54100 without puller and equipped with attachments overhanging the front of the cloth plate	54
21377 AP	Tray, 5 1/2" high, hinged body and front section, for nonsubmerged installations of Styles 54100 B-4, 54100 C-4	55
21377 AS	Tray, 3 3/4" high, hinged body and front section, for semisubmerged isolated installations of styles in Classes 51200, 51300, 51400, 51500, 51700, 51900, 54100 equipped with Class 21700 puller and attachments overhanging the front of the cloth plate.	—
21385 B	Tape Reel Exle (screw No. 201 C).	53
21388	Wrench, single end, 3/8 inch opening.	42
21388 N	" double end, 3/16 and 5/16 inch openings.	42
21388 R	" double end, 3/8 and 1/2 inch openings	42
21388 X	" for main shaft bearing housing.	53
21388 Z	Wrench, for setting needle lever stud with respect to oil groove. Stud is set correctly when the pin hole nearest the periphery is up and a line drawn between the two pin holes is 45 degrees to the right of the vertical.	42
21388 AE	Socket Wrench Assembly, for 9/32 inch and 3/8 inch hexagonal nuts, for looper lever ball stud locking stud and tilting feed mechanism	41
21394	Utility Grinder, including emery wheel, 5 inches diameter, 1/4 inch face, round belt drive, recommended speed 3000 R.P.M.	—
21394 G	Emery Wheel, 5 inches diameter, 1/4 inch face, 3/8 inch hole, grade "M" emery 60	—
21394 H	Emery Wheel, 5 inches diameter, 1/2 inch face, 3/8 inch hole, grade "M" emery 60	—
21394 K	Utility Grinder, including emery wheel, 5 inches diameter, 1/2 inch face, round belt drive, recommended speed 3000 R.P.M.	—

at Davis

LIST OF PARTS

Symbol to Order by	The figures in the last column refer only to the plates illustrating the parts and are not to be used in ordering. Refer to pink insert for prices.	Plate No.
21396 C	Needle Thread Lubricator Oil Reservoir Assembly, for Styles 51300 D, 51500 D; one each Nos. 660-73, 660-74, 660-75, 11638 M, 21396 AL, 21396 AP.	52
21396 AG	Needle Thread Lubricating Felt.	—
21396 AL	Needle Thread Lubricator Oil Reservoir Adapter	—
21396 AP	Needle Thread Lubricator Oil Reservoir Tube	—
21657-1	Tension Release Disc Separator, for Styles 51200 A, 51200 G, 51200 H	34
21657-2	Tension Release Disc Separator, for styles in Classes 51300, 51700, Styles 51200 B, 51200 C, 51200 J, 51400 G	34
21657-3	Tension Release Disc Separator, for Styles 51900 B, 51900 C.	34
21657-4	Tension Release Disc Separator, for styles in Classes 51500, 51400; also Styles 51400 A, 51400 B, 51400 C, 51400 D, 51400 E, 51400 F, 51400 H, 51400 J, 51400 K, 51400 L, 51400 M, 51400 N	34
21657 A	Tension Release Rock Shaft.	35
21657 B	" " Rock Shaft Connection (clamp screw No. 22585).	27
21657 C	Tension Release Rock Shaft Lever (clamp screw No. 22596, stud No. 22594).	34
21657 D	Tension Release Rock Shaft Lever Link (stud No. 22515).	34
21657 E	Tension Release Disc Separator Washer, for styles in Classes 51400, 51500, Styles 51200 A, 51200 G, 51200 H, 51900 A.	20
21660 A	Knee Press Assembly, for Style 51700 F, one each Nos. 21661, 21662, 21663, 21663 A, 21664, two each Nos. 98, 9271, 21665 and five No. 69 FD.	47
21661	Knee Press Shaft.	47
21662	" " Shaft Hanger	47
21663	" " Plate Rod.	47
21663 A	" " Lever, for Style 51700 F	47
21664	" " Plate (set screw No. 69 FD).	47
21665	" " Plate Rod Connection; also for No. 21663 A (screw No. 69 FD).	47
21677	" " Bell Crank Arm, for Style 51400 G	47
21680 AK	Base Plate, for nonsubmerged and semisubmerged installations on six isolators	54
21691 A	Knee Press Assembly, for Style 51400 G; one each Nos. 421 C-10, 21661, 21662, 21663, 21664, 21677; two each Nos. 9271, 21665. Specify component parts in ordering	48

LIST OF PARTS

Symbol to Order by	The figures in the last column refer only to the plates illustrating the parts and are not to be used in ordering. Refer to pink insert for prices.	Plate No.
21697 C	Belt Take-up Assembly, for "V" belt on "Electro Drive" installations.	51
21698-2	Vibration Insulator, two inches long, for tables	38
21698-4	Vibration Insulator, four inches long.	38
21698-5	" " five inches long.	38
21698-6	" " six inches long.	38
	Note: Special lengths will be furnished on re- quest. Part of the table leg is shown in the illustration for clarity	
21701 A	Base Plate, for machines equipped with Class 21700 Puller	—
21708	Puller Driving Eccentric Connecting Rod Tube, for Styles 51300 D, 51500 D, 51700 F, 51700 G, 54100 B, 54100 C (nut, left thread No. 15430 C, nut, right thread No. 15430 D)	35
21708 B	Puller Driving Eccentric Connecting Rod, for Style 51400 G.	34
21723 C	Puller Presser Roller Axle, for Style 51400 G	35
21724 A	" " Roller Axle Spring.	21
21725	" " Roller Axle Spring Screw.	16
22504	Screw, for guide leading strip to feed dog on Style 51700 E.	17
22507	Set Screw, square head, cup point, 1/4 inch diameter, 20 threads per inch, 3/8 inch long, for upper tape reel support vertical rod connection	17
22508	Set Screw, square head, cup point, 1/4 inch diameter, 20 threads per inch, 1/2 inch long, for upper tape reel post; also for No. 21173 B.	17
22509	Set Screw, square head, cup point, 5/16 inch diameter, 18 threads per inch, 1/2 inch long, for thread stand base; also for No. 21104 C.	18
22513	Screw, for presser bar connection guide plate	15
22514	" 7/16 inch long, for cloth plate attach- ments	17
22515	Stud, for tension release rock shaft lever link	16
22517	Screw, for puller connecting rod guard on Style 51400 G.	17
22519	Set Screw, hexagonal head, for needle lever ball stud.	16
22521	Screw, plus size, for cloth plate (tap No. V118).	16
22524	Screw, for upper crank chamber cover on Styles 51200 A, 51200 G, 51200 H, 51400 G, 51900 B, 51900 C.	15

LIST OF PARTS

Symbol to Order by	The figures in the last column refer only to the plates illustrating the parts and are not to be used in ordering. Refer to pink insert for prices.	Plate No.
22525	Screw, .010 inch plus size, length overall 5/16 inch, otherwise same as No. 87.	15
22528	Screw, for feed dogs, also for Nos. 23229 P, K51165, 51457, 52857, 52857 A.	16
22532	Stripper Blade Adjusting Stud, for body folder on Style 51700 E (washer No. 12957 E).	17
✓ 22539 C	Plug Screw, for cloth plates	17
22542	Screw, for looper drive lever barrel clamp on Styles 51200 A, 51200 G, 51200 H, 51400 G, 51900 B, 51900 C; also for No. 7486 PA	16
22547 A	Screw, for needle thread controller rack thread guide.	15
22548	" for facing folder, also for No. 23447 B	17
22557	" for collapsible folder lever on Style 51700 F	17
22559 A	Bearing Screw, lower, for looper drive connection on styles in Classes 51300, 51500, 51700, 54100, Styles 51200 B, 51200 C, 51200 J, 51400 A, 51400 B, 51400 C, 51400 D, 51400 E, 51400 F, 51400 H, 51400 J, 51400 K, 51400 L, 51400 M, 51400 N, 51900 A	17
22559 B	Bearing Screw, upper, for looper drive connection on styles in Classes 51300, 51500, 51700, 54100, Styles 51200 B, 51200 C, 51200 J, 51400 A, 51400 B, 51400 C, 51400 D, 51400 E, 51400 F, 51400 H, 51400 J, 51400 K, 51400 L, 51400 M, 51400 N, 51900 A	18
22559 C	Screw, for puller driving eccentric bearing on Style 51400 G.	17
22560	Screw, for needle lever link pin spring; also for No. HA 1286	15
22560 A	" for adjusting feed dog holder on styles in Class 54100.	16
22560 B	Set Screw, headless, for feed bars; also for Nos. HA 1286, 51462 B, 51751, 54134 G.	15
22561	Screw, for presser foot spring on Style 51900 C.	15
22565 C	Screw, for lower differential feed roll on Style 51700 E.	15
22566 A	Stud, for lifter lever	18
22569	Screw, for feed crank link; also for No. 51245	17
22570	" fillister head, for throat plates	15
22571	Plug Screw, for frame thread eyelet on Styles 51500 A, 51500 C, 51500 G.	17
22571 A	Plug Screw, for spring pressed felt wick on main shaft bearings and main shaft oil reservoir	17

LIST OF PARTS

Symbol to Order by	The figures in the last column refer only to the plates illustrating the parts and are not to be used in ordering. Refer to pink insert for prices.	Plate No.
22580	Set Screw, 9/64 inch long, for outer needles on Styles 51900 B, 51900 C; also for Nos. 51423 B, 51523 C	15
22581	Screw, for differential feed roll yoke support on Style 51700 E; also for No. K55110.	17
22585	Clamp Screw, for tension release rock shaft connection; also for Nos. 23437 B, 52894 J	15
22585 B	Screw, for needle guard	17
22586 B	Plug Screw, for sight feed oiler hole on Styles 51400 A, 51400 B, 51400 C, 51400 D 51400 F, 51400 H, 51400 J, 51400 K, 51400 L, 51400 M, 51400 N, 51900 A. . . .	15
22587	Screw, for puller driving eccentric bearing on Styles 51300 D, 51500 D, 51700 F, 51700 G, 54100 B, 54100 C	18
22593	Screw, for strip folder sliding base spring on Style 51700 E; also for No. 23447 A. .	15
22594	Stud, for tension release rock shaft lever	16
22596	Clamp Screw, for tension release rock shaft lever; also for No. 43294 A	17
22597	Spot Screw, for pulley, also for No. 7490 P	16
22597 A	Set Screw, for pulley; also for No. 51242 A	16
22598 C	Stud, for tension release disc separator on Styles 51200 A, 51200 G, 51200 H, 51400 A 51400 B, 51400 C, 51400 D, 51400 E, 51400 F, 51400 H, 51400 J, 51400 K, 51400 L, 51400 M, 51400 N, 51900 A. . . .	17
22599	Screw, for presser foot front section equalizing spring on Style 51900 C. . . .	15
22632 F-24	Screw, square head, cup point, 3/16 inch diameter, 3/8 inch long, 24 threads per inch, for thread stand wires.	16
22637 D	Screw, flat head, 5/16 x 1 3/4 inches, 18 threads per inch, for fastening machine to puller base plate.	18
22704	Screw, for feed clutch roller spring on Style 51400 G	15
22711	Screw, for looper thread guard on styles in Class 51700; Styles 51200 A, 51200 G, 51200 H, 51900 B, 51900 C; also for No. 243	16
22716	Screw, for looper drive eccentric oil disc	15
22716 A	" for looper drive eccentric oil disc washer	15
22726	Hinge Screw, for throw out folder and guide on Style 51300 C.	16

528500

LIST OF PARTS

Symbol to Order by	The figures in the last column refer only to the plates illustrating the parts and are not to be used in ordering. Refer to pink insert for prices.	Plate No.
22726 A	Screw, for cloth plate cover spring; also for No. 51777.	15
22729	Clamp Screw, for needle on Style 51500 G . . .	17
22730	Screw, for frame needle thread guide No. 51758 A, also for Nos. 23406 B, 23406 C, 23406 D.	16
22735	Pivot Stud, for binder bracket on Style 51200 B, also for No. 23449 A.	16
22743	Screw, for upper differential feed roll on Style 51700 E.	15
22747	Screw, for puller feed clutch disc on Style 51400 G; also for No. 54185.	16
22752	Set Screw, with pilot, for middle needle on Nos. 8 and 9 gauge Styles 51900 B, 51900 C	15
22752 A	Set Screw, with pilot, for middle needle on Nos. 5, 6 and 7 gauge styles in Class 51900	15
22752 B	Screw, for adjusting presser foot bottoms on Styles 51400 B, 51400 C, 51400 D, 51400 F, 51400 N.	16
22757	Screw, for looper rocker link on styles in Class 51700.	17
22764 A	Spot Screw, for parallel take-up	15
22768	Screw, for needle bar and needle lever thread eyelets, also for Nos. 51134, 51134 A, 51236 B.	15
22769	Screw, for crank chamber oil tube clamp.	16
22773	" for folder swinging arm	17
22787 B	Stud, for elastic guide on Style 51400 G	17
22788	Screw, for puller frame on Style 51400 G.	18
22794 B	" for parallel take-up flange	18
22795	Stitch Regulating Screw.	17
22797	Stop Screw, for differential feed roll yoke support on Style 51700 E	15
22799	Hinge Screw, length overall 21/32 inch, diameter .177 inch, for presser foot bottom on Style 51700 F.	17
22799 B	Hinge Screw, length overall 19/32 inch, diameter .088 inch, for presser foot bottoms on Styles 51300 A, 51300 C, 51400 A, 51400 E, 51400 K.	16
22799 C	Hinge Screw, length overall 49/64 inch, diameter .088 inch, for presser foot bottom on Styles 51500 A, 51900 B.	16
22799 D	Hinge Screw, length overall 49/64 inch, diameter .124 inch, for presser foot bottom on Styles 51400 B, 51400 C, 51400 D, 51400 F, 51400 N, 51700 C, 51700 D.	17

23449

LIST OF PARTS

Symbol to Order by	The figures in the last column refer only to the plates illustrating the parts and are not to be used in ordering. Refer to pink insert for prices.	Plate No.
22799 E	Hinge Screw, length overall $4\frac{1}{64}$ inch, diameter .088 inch, for presser foot bottoms on Style 51900 A.	16
22799 L	Regulating Screw, for presser foot guiding section on Style 51900 C	16
22799 N	Screw, for cloth plate slide No. 51202	15
22801	Stop Screw, for stitch regulating screw; also needle guard pivot screw	15
22813	Screw, headless, for lifter treadle pin.	15
22823 A	Screw, $1\frac{1}{16}$ inch long, hexagonal head, for attaching machine to base plate No. 21680 AK	18
22823 B	Screw, $1\frac{9}{32}$ inches long, hexagonal head, for attaching machine to base plate No. 21680 AK	18
22824 A	Set Screw, hexagonal head, for needles on Style 51500 C.	15
22829	Locking Screw, for looper rocker cone nut.	16
22833	Screw, for parallel take-up cast-off	17
22834	" for regulating needle guards.	16
22835	Stud, for looper rocker link	18
22837	Thumbscrew, for face plate	17
22839	Screw, fillister head, for throat plate supports	16
22840	Adapter Screw, for frame needle thread eyelet on styles in Classes 51400, 51700, 51100, Styles 51200 B, 51200 C, 51200 J, 51300 B, 51300 C, 51300 D, 51400 G, 51500 D, 51900 A	17
22840 A	Screw for regulating presser foot bottom on Styles 51200 B, 51200 C, 51400 E; also for Nos. 51134, 51134 A.	16
22840 B	Adapter Screw, for frame needle thread eyelet on Style 51300 A	17
22845 A	Hinge Screw, for presser foot yoke on Style 51900 C.	15
22848	Screw, for looper thread guard, also for Nos. 51758, 52885 G.	17
22849	" right, for upper crank chamber oil reservoir	16
22863	Adjusting Screw, for feed dog holder	15
22863 A	Folder Base Regulating Screw, for Styles 51400 B, 51400 C, 51700 C, 51700 D	17
22864	Needle Lever Link Pin Clamp Screw (nut No. 51250 C)	17
22866	Plug Screw, for opening on top of bed, for Style 51400 G.	16
22874	Screw, for folder swinging arm support	18
23100	Double Edge Folder and Guide, $\frac{3}{64}$ inch capacity, for Style 51200 G (screw No. 25 C)	31
23151 A	Plate Folder and Guide, $\frac{1}{4}$ inch capacity, for Style 51900 C (screw No. 25 C)	32

LIST OF PARTS

Symbol to Order by	The figures in the last column refer only to the plates illustrating the parts and are not to be used in ordering. Refer to pink insert for prices.	Plate No.
23160	Lap Seam Guide, non adjustable, for Style 51500 D (screw No. 25 C)	31
23168 N	Hemmer, for 1 1/2 inch hem on No. (12-64-12) gauge Styles 54100 C, 54100 E (screw No. 25 C)	45
23168 P	Hemmer, for 1 5/8 inch hem on No. (16-64-16) gauge Styles 54100 C, 54100 E (screw No. 25 C)	45
23168 Q	Hemmer, for 7/8 inch hem on No. 48 gauge Style 51400 N (screw No. 25 C)	45
23184 E	Base, for throw-out folder and guide on Style 51300 C	—
23184 G	Adjustable Guide, lower, for throw-out folder on Style 51300 C (screw No. 187 A)	—
23184 K	Folder and Guide Assembly, throw-out type, for welt seaming trousers on Style 51300 C, one each Nos. 23184 E, 12957 E, 22726, 23184 G, 23184 L, 23184 M; four No. 187 A	32
23184 L	Upper Folder, for throw-out folder and guide assembly on Style 51300 C (pivot screw No. 22726, pivot screw washer No. 12957 E)	—
23184 M	Adjustable Guide, upper, for throw-out folder on Style 51300 C (screw No. 187 A)	—
23215 BC-5/8	Binder, for selvage edge and prefolded binding 5/8 inch wide, 5/32 inch capacity for body fabric, on Style 51200 B	33
23215 BC-3/4	Binder, for selvage edge and prefolded binding 3/4 inch wide	33
23215 BC-7/8	Binder, for selvage edge and prefolded binding 7/8 inch wide	33
23229 M	Binder Screw No. 90 Folder Swinging Arm Support, for Styles 51400 B, 51400 C, 51700 C, 51700 D, 51700 G, 51700 H (screw No. 22874)	—
23229 N	Folder Swinging Arm (pivot screw No. 22773, thumbscrew No. 25 T)	—
23229 P	Folder Bracket (screw No. 22528)	—
23229 Q	Folder Clamp (screw No. 25 S, regulating screw No. 22863 A)	—
23322 AB-3/4	Binder, for cut edge binding 3/4 inch wide, finishes 7/32 inch, 1/8 inch capacity for body fabric, on Style 51200 A	33
23322 AB-7/8	Binder, for cut edge binding 7/8 inch wide, finishes 1/4 inch, 1/8 inch capacity for body fabric	33

LIST OF PARTS

Symbol to Order by	The figures in the last column refer only to the plates illustrating the parts and are not to be used in ordering. Refer to pink insert for prices.	Plate No.
23322 AB-1	Binder, for cut edge binding 1 inch wide, finishes 9/32 inch, 1/8 inch capacity for body fabric.	33
23322 AB-1 1/8	Binder, for cut edge binding 1 1/8 inches wide, finishes 11/32 inch, 5/32 inch capacity for body fabric.	33
23322 AB-1 1/4	Binder, for cut edge binding 1 1/4 inches wide, finishes 13/32 inch, 5/32 inch capacity for body fabric.	33
23322 AC	Binder Screw No. 90	
23324 G	Binder Support, for Style 51200 A (screw No. 90).	33
23324 H	Collapsible Folder Connection Link, for Style 51700 F (stud No. 134).	30
23324 J	Collapsible Folder Operating Lever (stud No. 22557).	30
23324 R	Collapsible Folder Operating Lever Stop (screw No. 25 CC)	30
23324 U	Collapsible Folder Connection, upper (adjusting screw No. 98 A, pivot stud No. 402).	48
23324 V	Scroll Connection Guide, for Style 51700 F (screw No. 93 A).	30
23360 C-1 1/2	Scroll Connection Guide Support (screw No. 93 A)	30
23360 F-1/2	Collapsible Folder, for 1 1/2 inch overall bands, uses strip cut 3 3/4 inches wide, on No. 88 gauge Style 51700 F (screw No. 25 C).	45
23386 E-7/16	Folder, for 1/2 inch button stay on Style 51200 J, uses strip cut 1 1/2 inches wide (screw No. 25 C).	45
23386 E-15/32	Reverse Hemmer, with shiftable elastic guide, for hemming bloomers with 7/16 inch hem on Style 51400 G	45
23386 E-1/2	Reverse Hemmer, for 15/32 inch hem.	45
23386 E-9/16	Reverse Hemmer, for 1/2 inch hem.	45
23386 E-19/32	Reverse Hemmer, for 9/16 inch hem	45
23386 E-5/8	Reverse Hemmer, for 19/32 inch hem.	45
23386 F	Reverse Hemmer, for 5/8 inch hem.	45
23386 G	Attaching Screw No. 25 C	
23386 H	Elastic Guide, for Style 51400 G (stud No. 22787 B).	33
23386 J	Elastic Guide Lever	27
	" " Stop, right (screw No. 90)	27
	" " Stop, left (screw No. 90)	27

LIST OF PARTS

Symbol to Order by	The figures in the last column refer only to the plates illustrating the parts and are not to be used in ordering. Refer to pink insert for prices.	Plate No.
23401 J-56	Center Plait Folder "Tru-Front" type, 1/32 inch capacity, for No. 56 gauge Styles 51700 C, 51700 D, plait extends 5/16 inch beyond the rows of stitches, finish width 1 1/2 inches, uses plait cut 2 5/8 inches and interlining strip cut 1 15/32 inches.	45
23401 K-48	Center Plait Folder "Tru-Front" type, 1/32 inch capacity, for No. 48 gauge Styles 51400 B, 51400 C; plait extends 1/4 inch beyond the rows of stitches, finish width 1 1/4 inches, uses plait cut 2 1/4 inches and interlining strip cut 1 7/32 inches.	45
23401 K-56	Center Plait Folder, "Tru-Front" type, 1/32 inch capacity, for No. 56 gauge Styles 51700 C, 51700 D, plait extends 1/4 inch beyond the rows of stitches, finish width 1 3/8 inches, uses plait cut 2 3/8 inches.	45

LIST OF PARTS

Symbol to Order by	The figures in the last column refer only to the plates illustrating the parts and are not to be used in ordering. Refer to pink insert for prices.	Plate No.
23405 L	Folder, for turning body of garment upwardly, 1/32 inch capacity, 5/16 inch fold on Styles 51400 C, 51700 C.	33
23405 N	Folder, for turning edge of sleeve up- wardly, 1/16 inch capacity, 1/4 inch fold on Styles 51400 G, 51400 H. . .	32
23406 B-7/8	Folder Screw No. 25 C Folder, for 7/8 inch button stay, uses 2 1/4 inch strip on Style 51400 M (screw No. 22730).	45
23406 C-1 5/8	Folder, for 1 5/8 inch single piece center plait, uses 3 3/4 inch strip on No. (16-64-16) gauge Styles 54100 B, 54100 D (screw No. 22730)	45
23406 D-1 1/2	Folder, for 1 1/2 inch single piece center plait, uses 3 1/2 inch strip on No. (12-64-12) gauge Styles 54100 B, 54100 D (screw No. 22730)	45

LIST OF PARTS

Symbol to Order by	The figures in the last column refer only to the plates illustrating the parts and are not to be used in ordering. Refer to pink insert for prices.	Plate No.
23421 U-18-1/16	Upper Scroll, 1/16 inch capacity, for No. 18 gauge two needle machines, and No. 9 gauge three needle mach- ines	32
23421 U-18-3/32	Upper Scroll, 3/32 inch capacity . . .	32
23421 U-18-1/8	" " 1/8 inch capacity.	32
23421 U-26-1/16	" " 1/16 inch capacity, for No. 26 gauge Style 51400 J.	32
23421 V-8-1/32	Upper Scroll, for lap seam feller, 1/32 inch capacity, for No. 8 gauge Style 51400 E.	32
23421 V-10-1/32	Upper Scroll, 1/32 inch capacity, for No. 10 gauge	32
23421 V-12-1/32	" " 1/32 inch capacity, for No. 12 gauge	32
23421 V-16-1/32	" " 1/32 inch capacity, for No. 16 gauge	32
	" " Screw No. 28	
23422 U-1/32	Lower Scroll and Base, for lap seam feller, 1/32 inch capacity, for Nos. 6, 8, 10 and 12 gauge Style 51400 A	32
23422 U-1/16	Lower Scroll and Base, 1/16 inch capacity, for Nos. 10, 12, 16 and 18 gauge Style 51400 A, also No. 26 gauge Style 51400 J, and Nos. 5, 6 and 7 gauge Style 51900 A.	32
23422 U-3/32	Lower Scroll and Base, 3/32 inch capa- city, for Styles 51500 A, 51900 B. . .	32
23422 U-1/8	Lower Scroll and Base, 1/8 inch capa- city, for Styles 51900 A, 51900 B. . .	32
23422 V-1/32	Lower Scroll and Base, 1/32 inch capa- city, for Style 51400 E.	32
	Lower Scroll and Base Screw No. 25 C	
23425 T	Washer Plate, for binders on Styles 51200 A, 51200 B	27
23425 U	Washer Plate, for cloth plate attach- ments.	32
23432 A	Folder Clamp, for upper folder on Styles 51700 G, 51700 H (screw No. 25 S).	30
23435-32	Facing Strip Folder, 1/32 inch capa- city, uses 1 inch strip, finishes 5/8 inch, for No. 32 gauge Style 51400 D.	45

LIST OF PARTS

Symbol to Order by	The figures in the last column refer only to the plates illustrating the parts and are not to be used in ordering. Refer to pink insert for prices.	Plate No.
23435-48	Facing Strip Folder, 1/32 inch capacity, uses 1 1/4 inch strip, finishes 7/8 inch, for No. 48 gauge Styles 51400 B, 51400 D	45
23435-64	Facing Strip Folder, 1/32 inch capacity, uses 1 1/2 inch strip, finishes 1 1/8 inches, for No. 64 gauge Style 51700 D. . .	45
	Facing Strip Folder Washer No. 9255	
	Facing Strip Folder Screw No. 22548	
23436	Facing Strip Folder Bracket, for Styles 51400 B, 51400 D, 51700 D (washer No. 9255, screw No. 136).	33
23437 A	Binder Bracket, for Style 51200 B (washer No. 12957 E, screw No. 22735)	33
23437 B	Binder Bracket Support (screw No. 22585). . .	33
23438 A	Supplemental Guide Plate, for Style 51200 A (screw No. 25 C).	30
23438 B	Supplemental Guide Platform, for Style 51200 B (screw No. 90).	30
23439 A	Pin Tension, for Styles 51200 A, 51200 B (screw No. 90).	30
23447-64	Strip Folder, for No. 64 gauge Style 51700 E	31
23447-72	" " for No. 72 gauge.	31
23447-80	" " for No. 80 gauge.	31
23447 A	" " Guide (screw No. 22593)	31
23447 B	" " Bracket (screw No. 22548)	31
23447 C	" " Sliding Base Spring (screw No. 22593).	21
23448-64	Guide, for leading strip to feed dog on No. 64 gauge Style 51700 E	31
23448-72	" for No. 72 gauge	31
23448-80	" for No. 80 gauge	31
	" Screw No. 22504	
	" Spring No. 51785	
	" Washer No. 8372 A	
23449	Body Folder, complete, 1/16 inch capacity, for Style 51700 E, one each Nos. 12957 E, 22532, 22735, 23449 A, 23449 B, 23449 C, two each Nos. 88, 187 A (attaching screw No. 25 C)	31
23449 A	Body Folder Sliding Base (pivot screw No. 22735, pivot screw washer No. 12957 E). . .	—
23449 B	Body Folder Sliding Base Guide (screw No. 605 A).	—
23449 C	Body Folder Spring (screw No. 187 A).	21
28604	Transmitter Lubricant, No. 3 Arctic Cup Grease, 5 lb. package	—

LIST OF PARTS

Symbol to Order by	The figures in the last column refer only to the plates illustrating the parts and are not to be used in ordering. Refer to pink insert for prices.	Plate No.
28606-1/2	Powdered Oil Stone, 1/2 lb. package	—
28606-1	" " " 1 lb. package	—
28619	Puller Presser Roller Axle Spring Ball, for Style 51400 G	19
28705	"Electro Drive," 1/2 H.P., A.C., 1 phase, 60 cycles, 105-115 volts, 3400 R.P.M.	—
28705 D	"Electro Drive," 1/2 H.P., A.C., 1 phase, 60 cycles, 220 volts, 3450 R.P.M.	—
28707 B	"Electro Drive," 1/2 H.P., A.C., 3 phase, 60 cycles, 210-230 volts, 3500 R.P.M.	—
28707 D	"Electro Drive," 1/2 H.P., A.C., 3 phase, 60 cycles, 440 volts, 3500 R.P.M.	—
28708	"Electro Drive," 1/2 H.P., D.C., 105-115 volts, 3000 R.P.M.	—
28708 A	"Electro Drive," 1/2 H.P., D.C., 210-230 volts, 3000 R.P.M.	—
29066 F	Needle Lever Connecting Rod Upper Bearing Assembly, one each Nos. 51216 A, 51243 B lapped together	40
129105 A	Looper Drive Eccentric Assembly, external oiling, includes eccentric No. 51443; for Styles 51200 A, 51200 G, 51200 H, 51400 G (set screw No. 98, spot screw No. 96, bearing screw, upper, No. 75 A, bearing screw, lower, No. 97 A)	39
129105 B	Looper Drive Eccentric Assembly; external oiling, includes eccentric No. 51343, for styles in Classes 51300, 51500, Styles 51200 B, 51200 C, 51200 J, 51900 B, 51900 C (set screw No. 98, spot screw No. 96, bearing screw, upper, No. 75 A, bear- ing screw, lower, No. 97 A)	39
129105 L	Looper Drive Eccentric Assembly, internal and external oiling, includes eccentric No. 51243 P, for styles in Class 51700; also Styles 51400 A, 51400 B, 51400 C, 51400 D, 51400 E, 51400 F, 51400 H, 51400 J, 51400 K, 51400 L, 51400 M, 51400 N, 51900 A (set screw No. 98, spot screw No. 96, bearing screw, upper, No. 22559 B, bearing screw, lower, No. 22559 A	39

LIST OF PARTS

Symbol to Order by	The figures in the last column refer only to the plates illustrating the parts and are not to be used in ordering. Refer to pink insert for prices.	Plate No.
‡29105 M	Looper Drive Eccentric Assembly, internal and external oiling, includes eccentric No. 51243 Q, for styles in Classes 51300, 51500, also Styles 51200 B, 51200 C, 51200 J (set screw No. 98, spot screw No. 96, bearing screw, upper, No. 22559 B, bearing screw, lower, No. 22559 A)	39
‡29105 N	Looper Drive Eccentric Assembly, internal and external oiling, includes eccentric No. 52840 G, for styles in Class 54100 (set screw No. 98, spot screw No. 96, bearing screw, upper, No. 22559 B, bearing screw, lower, No. 22559 A)	39
‡29138 H	Puller Driving Eccentric Assembly, throw .203 inch, stitch range 7 to 13 per inch, includes eccentric No. 21703 H, for Style 51700 F (spot screw No. 81, set screw No. 95, bearing screw No. 22587).	39
‡29138 J	Puller Driving Eccentric Assembly, throw .156 inch, stitch range 11 to 16 per inch, includes eccentric No. 21703 J, for Styles 54100 B, 54100 C (spot screw No. 81, set screw No. 95, bearing screw No. 22587).	39
‡29138 K	Puller Driving Eccentric Assembly, throw .116 inch, stitch range 15 to 26 per inch, includes eccentric No. 21703 K, for Style 51700 G (spot screw No. 81, set screw No. 95, bearing screw No. 22587).	39
‡29138 L	Puller Driving Eccentric Assembly, throw .382 inch, stitch range 4 to 7 per inch, includes eccentric No. 21703 F, for Styles 51300 D, 51500 D (spot screw No. 81, set screw No. 95, bearing screw No. 22587).	39
‡29138 M	Puller Driving Eccentric Assembly, throw .160 inch, stitch range 7 to 12 per inch, includes eccentric No. 53551 A, for Style 51400 G (spot screw No. 81, set screw No. 95, bearing screw No. 22559 C).	39
29192	Looper Rocker Assembly, for styles in Classes 51200, 51300; one each Nos. 51213, 15465 F, 51745 lapped together; also one each Nos. 258 A, 22829 and two No. 88	40
29192 A	Looper Rocker Assembly, for Styles 51400 A, 51400 B, 51400 C, 51400 D, 51400 E, 51400 F, 51400 K, 51400 L, 51400 M, 51400 N; one each Nos. 51413, 15465 F, 51745 lapped together; also one each Nos. 258 A, 22829 and two No. 88	40

LIST OF PARTS

Symbol to Order by	The figures in the last column refer only to the plates illustrating the parts and are not to be used in ordering. Refer to pink insert for prices.	Plate No.
29192 B	Looper Rocker Assembly, for styles in Class 51900; one each Nos. 51913, 15465 F, 51745 lapped together; also one each Nos. 258 A, 22829 and two No. 88.	40
29192 C	Looper Rocker Assembly, for styles in Class 51700; one each Nos. 51713, 15465 F, 51745 lapped together; also one each Nos. 258 A, 22829 and two No. 88.	40
29192 D	Looper Rocker Assembly, for styles in Class 51500, also Styles 51400 G, 51400 H, 51400 J; one each Nos. 51513, 15465 F, 51745 lapped together; also one each Nos. 258 A, 22829 and two No. 88.	40
29202 A-1	Needle Bar Assembly, for No. 1 gauge Style 51500 C; one each Nos. 53517 C-16, 52818-8 and two No. 22824 A.	—
29202 G-1	Needle Bar Assembly, for No. 1 gauge Style 51500 G; one each Nos. 51517 G-1, 51518 G-1.	—
29402	Lifter Treadle Assembly; one each Nos. 422, 423, 424, 22813.	51
29481 C	Center Plait Folder Arm Assembly "Tru-Front" type, for Styles 51400 B, 51400 C, 51700 C, 51700 D; one each Nos. 25 S, 25 T, 22773, 22863 A, 23229 M, 23229 N, 23229 P, 23229 Q; two each Nos. 93 A, 22528 (attaching screw No. 93)	48
29730 A	Parallel Take-up Assembly, for styles in Class 51700; also Styles 51200 A, 51200 G, 51200 H, 51400 G, 51900 B, 51900 C; one each Nos. 51423, 89, 22764 A, 22833, 51404, 51461, 51461 A, 51461 B, 51461 C and three No. 22794 B.	—
35731 A	Presser Bar Connection Guide Plate (screw No. 22513)	27
35733 B	Presser Spring Regulating Screw Lock Nut, for machines equipped with external presser spring	19
35759	Needle Bar Connection.	28
35768 A	Screw, left, for crank chamber oil reservoir; also for No. 52887	16
35788 B	Crank Chamber Oil Reservoir Cover (screw No. 605)	37
35818 N-8	Needle Holder, marked "C8" for No. 8 gauge Style 51900 B (spot screw No. 89, needle set screw, middle, No. 22752, outer No. 22580)	22

LIST OF PARTS

Symbol to Order by	The figures in the last column refer only to the plates illustrating the parts and are not to be used in ordering. Refer to pink insert for prices.	Plate No.
35818 N-9	Needle Holder, marked "C9" for No. 9 gauge Styles 51900 B, 51900 C (spot screw No. 89, needle set screw, middle, No. 22752, outer No. 22580).	22
35820 P-8	Presser Foot Assembly, for No. 8 gauge Style 51900 B; one each Nos. 35830 P-8, 91, 22799 C, 35830, 51930	10
35820 P-9	Presser Foot Assembly, for No. 9 gauge Style 51900 B; one each Nos. 35830 P-9, 91, 22799 C, 35830, 51930	10
35820 R-9	Presser Foot Assembly, for No. 9 gauge Style 51900 C; one each Nos. 35830 R-9, 35830 G, 73 A, 91 D, 22561, 22599, 22799 L, 35830 B, 35830 C, 35830 D, 35830 E, 35830 F, 35830 H, 35830 K and six No. 22845 A	11
35830	Presser Foot Shank, for Styles 51500 A, 51900 B	—
35830 B	Presser Foot Shank, for Styles 51900 C (clamp screw No. 91 D).	—
35830 C	Presser Foot Yoke, for Style 51900 C (hinge screw No. 22845 A).	12
35830 D	Presser Foot Spring, for Style 51900 C (screw No. 22561).	22
35830 E	" " Yielding Section, for Style 51900 C (lock screw No. 22799 L)	12
35830 F	" " Yielding Section Adjusting Nut, for Style 51900 C	12
35830 G	Presser Foot Bottom, rear section, for Style 51900 C (hinge screw No. 22845 A)	—
35830 H	Presser Foot Bottom, Rear Section Equal- izing Spring, for Style 51900 C (screw No. 73 A).	22
35830 K	Presser Foot Bottom Front Section Equal- izing Spring, for Style 51900 C (screw No. 22599).	22
35830 P-8	Presser Foot Bottom, for No. 8 gauge Style 51900 B.	—
35830 P-9	" " " for No. 9 gauge Style 51900 B.	—
35830 R-9	Presser Foot Bottom, front section, for No. 9 gauge Style 51900 C (hinge screw No. 22845 A).	12
35831 A	Needle Thread Controller Rack Thread Guide, for Styles 51200 A, 51200 G, 51200 H, 51900 B, 51900 C (screw No. 22547 A).	24

LIST OF PARTS

Symbol to Order by	The figures in the last column refer only to the plates illustrating the parts and are not to be used in ordering. Refer to pink insert for prices.	Plate No.
35833 A	Presser Spring Regulating Stud, for machines equipped with external presser spring (nut No. 258 A)	25
35833 C	Presser Spring Plate	44
38208 G-26	Looper, front, for No. 26 gauge Style 51500 D (set screw No. 73)	13
38209 A	Looper, for Style 51300 D; also back looper for Style 51500 D (set screw No. 73).	13
39132 V	End Cover Hinge Pin, for Style 51400 G	—
39135	Feed Bar Shaft, 2 inches long (set screw No. 77).	35
39141 G	Nut, for puller connecting rod ball joint on Style 51400 G	19
39193	Crank Chamber Oil Reservoir Sight Gauge Assembly, for styles in Classes 51300, 51500, 51700, 51400; also Styles 51400 A, 51400 B, 51400 C, 51400 D, 51400 E, 51400 F, 51400 H, 51400 J, 51400 K, 51400 L, 51400 M, 51400 N, 51900 A; one each Nos. 39193 A, 39193 B, 660-92, 660-93, 666-49	29
39193 A	Crank Chamber Oil Reservoir Sight Gauge Glass Tube Cover	29
39193 B	Crank Chamber Oil Reservoir Sight Gauge Base	—
39236 A	Needle Guard Washer, for Styles in Classes 51200, 51300, 51400, 51500, 51700, 51900.	20
K40881	Folder, for 3/4 inch button stay on Style 51200 J; uses strip cut 2 1/8 inches wide, 1/32 inch capacity (screw No. 25 C).	—
41047	Looper Connecting Rod, 2 3/8 inches long, for 96 and narrower gauge Styles in Class 51700 (nut, right thread No. 18, nut, left thread No. 269).	25
41071 G	Nut, for oil tube brace on styles in Classes 51300, 51500; also Styles 51200 B, 51200 C, 51200 J, 51400 A, 51400 B, 51400 C, 51400 D, 51400 E, 51400 F, 51400 H, 51400 J, 51400 K, 51400 L, 51400 M, 51400 N, 51900 A	19
41258	Puller Clutch Roller, for Style 51400 G.	20
41258 A	" Clutch Roller Spring (screw No. 22704).	21
41258 B	" Feed Clutch Disc, left (screw No. 22747).	20

LIST OF PARTS

Symbol to Order by	The figures in the last column refer only to the plates illustrating the parts and are not to be used in ordering. Refer to pink insert for prices.	Plate No.
41258 D	Puller Clutch Housing, for Style 51400 G (spot screw No. 81, set screw No. 95) . . .	43
41258 E	Puller Feed Clutch Disc, right (screw No. 22747)	20
41258 CG	Puller Clutch Lever.	—
43220 F	Presser Foot Assembly, for Style 51300 A; one each Nos. 43230 J, 43230 H, 91, 22799 B.	12
43230 H	Presser Foot Shank, for Style 51300 A (clamp screw No. 91)	—
43230 J	Presser Foot Bottom, for Style 51300 A . . .	—
43266	Looper Thread Tension Post Nut	19
43294 A	Oil Drain Support (screw No. 22596).	48
43294 D	Oil Drain Pipe, 3 inches long.	42
43297	Needle Thread Take-up Spring, for Style 51300 A.	22
43297 A	Needle Thread Take-up Spring Stop.	27
43443 Q	Nut, for differential feed intermediate gear stud on Style 51700 E.	19
K48039	Needle Thread Lubricator Cup, for Styles 51300 D, 51500 D, 51900 C (screw No. 25 S)	—
K48964	Folder, for turning edge of sleeve upwardly, 1/32 inch capacity, 1/8 inch fold, on Style 51400 L (screw No. 25 C)	—
K49039	Piping Guide, with cord tube, uses 5/8 inch bias strip and 3/32 inch cord, for Styles 51700 G, 51700 H (screw No. 187 A)	—
K49157	Hemmer, for 5/8 inch hem, 1/32 inch capa- city, on Style 51400 F (screw No. 25 C). . .	—
K49290	Feed Dog, for No. 128 gauge Styles 51700 G, 51700 H (screw No. 22528).	—
K49640	Folder, for 7/8 inch button stay, 1/32 inch capacity, uses 2 3/8 inch strip, on Style 51200 J (screw No. 25 C)	—
K49746	Folder, for 1 inch button stay, 1/32 inch capacity, uses 2 5/8 inch strip, on Style 51200 J (screw No. 25 C)	—
K49992	Throat Plate Support, for Styles 51700 G, 51700 H (screw No. 80)	—
K49995	Needle Guard, for Styles 51700 G, 51700 H (screw No. 22585 B).	—
K50068	Cloth Plate Cover, 6 15/64 inches long, for Styles 51700 G, 51700 H.	—
K50176	Looper Rocker Link, for No. 88 gauge Style 51700 F.	—
K50177	Looper Rocker Spacing Plate, for No. 88 gauge Style 51700 F.	—

LIST OF PARTS

Symbol to Order by	The figures in the last column refer only to the plates illustrating the parts and are not to be used in ordering. Refer to pink insert for prices.	Plate No.
K50370	Tray, 5 1/2 inches high, hinged body and front section, for nonsubmerged isolated installation of styles in Classes 51200, 51300, 51400, 51500, 51700, 51900 equipped with Class 21700 Puller and having attachments that overhang the front of the cloth plate	—
K50410	Presser Foot, for No. 128 gauge Styles 51700 G, 51700 H (clamp screw No. 91, yielding section spring, left, No. 16194, yielding section spring, right, No. 8040, yielding section spring attaching screw No. 605, yielding section spring adjusting screw No. 605 A, strip guide No. 16194 B, strip guide screw No. 73 A)	—
K50909	Throat Plate, for No. 128 gauge Styles 51700 G, 51700 H (screw No. 87)	—
K50911	Looper Rocker Link, for No. 128 gauge Styles 51700 G, 51700 H.	—
K50912	Looper Rocker Spacing Plate, for No. 128 gauge Styles 51700 G, 51700 H	—
‡51134	Feed Bar, including tiltable feed dog holder, for styles in Classes 51200, 51300, 51500, 51700, 51900; also Styles 51400 A, 51400 B, 51400 C, 51400 D, 51400 E, 51400 F, 51400 H, 51400 J, 51400 K, 51400 L, 51400 M, 51400 N (set screw No. 22560 B, feed dog supporting screw No. 538, feed dog holder adjusting screw No. 22863, link pin screw No. 22768).	43
‡51134 A	Feed Bar, including tiltable feed dog holder, for Style 51400 G (set screw No. 166, feed dog supporting screw No. 538, feed dog holder adjusting screw No. 22863, link pin screw No. 22768).	43
51134 G	Feed Dog Holder, tiltable (nut No. 258 A, washer No. 6042 A).	27
51142	Feed Lift Eccentric, for Style 51300 B (spot screw No. 96)	28
51147	Main Shaft Collar (screw No. 95).	20
K51165	Folder Bracket, for use with folder swinging arm on Styles 51700 G, 51700 H (screw No. 22528).	—
51170 B	Needle Thread Take-up, for Style 51200 A (screw No. 90).	38

LIST OF PARTS

Symbol to Order by	The figures in the last column refer only to the plates illustrating the parts and are not to be used in ordering. Refer to pink insert for prices.	Plate No.
51170 C	Needle Thread Take-up Post, for styles in Classes 51200, 51300, 51400, 51500, 51900	24
51170 D	Needle Thread Take-up Post Lock Nut	19
51201	Cloth Plate, for Styles 51200 A, 51900 B, 51900 C, using throat plates 3 1/8 inches long.	54
51201 A	Cloth Plate, for Styles 51200 G, 51200 H, using throat plates 2 1/4 inches long . . .	54
51201 B	Cloth Plate, for Styles 51200 B, 51300 B, 51400 F, 51400 L, 51500 A, 51500 C, 51500 G using throat plates 3 1/8 inches long . . .	54
	Cloth Plate Screw No. 80	
51202	Cloth Plate Slide, rear, 1 1/2 inches long, for styles in Classes 51300, 51400, 51500, 51700, 54100; also Styles 51200 B, 51200 C, 51200 J, 51900 A (stop screw No. 22799 N)	38
51205 A	Feed Dog, for Style 51200 A (screw No. 22528)	8
51208	Looper, for Styles 51200 C, 51300 A, 51300 B, 51300 C (set screw No. 73).	13
51208 D	Looper, for Styles 51200 H, 51200 J; also back looper for Style 51400 H (set screw No. 73)	13
51213	Looper Rocker, for styles in Classes 51200, 51300	40
‡51215 A	Needle Lever, steel, for styles in Classes 51200, 51300, 51500, 51900, 54100 (set screw for link pin No. 77).	50
‡51215 B	Needle Lever, lynite, for styles in Classes 51400, 51700, (clamp screw for link pin No. 22864, clamp screw nut No. 51250 C)	50
51216	Needle Lever Connecting Rod Tube (nut, left thread, No. 15430 C, nut, right thread, No. 15430 D).	35
51216 A	Needle Lever Connecting Rod Upper Bearing (screw No. 97 A).	40
51217	Needle Bar, for styles in Classes 51200, 51300 (screw No. 88 A).	36
51220 A	Presser Foot, for Style 51200 A (clamp screw No. 91)	12
51220 J	Presser Foot, for Style 51200 J (clamp screw No. 91, yielding side spring No. 11534, yielding side spring screw No. 605)	11
51221	Pulley, working diameter 2 1/2 inches, for styles in Class 51400, Styles 51200 A, 51200 G, 51200 H, 51700 C, 51700 D, 51700 E, 51700 G, 51700 H, 51900 A (spot screw No. 22597, set screw No. 22597 A) . .	39

LIST OF PARTS

Symbol to Order by	The figures in the last column refer only to the plates illustrating the parts and are not to be used in ordering. Refer to pink insert for prices.	Plate No.
51222	Main Shaft, left section, for styles in Classes 51200, 51300, 51400, 51500, 51700, 51900.	49
‡51222 B	Crankshaft Assembly, for Styles 51200 B, 51200 C, 51200 J; includes crankshaft No. 51222 A (bearing screw No. 75 A).	49
51224 A	Throat Plate, for Style 51200 A	5
51224 B	" " for Style 51200 B	5
	" " Screw No. 22570	
51225	Needle Guard, for styles in Classes 51200, 51300 (screw No. 22585 B, washer No. 39236 A	14
51235	Feed Rocker (screw No. 98).	43
51235 A	" " Arm (clamp screw No. 93).	43
51235 B	" " Shaft, 4 7/16 inches long	35
51236	Feed Crank Link (oil wick No. 666-19, shim No. 1248, screw No. 22569, nut No. 7947).	28
51236 A	Feed Crank Link Pin (screw No. 77).	25
51236 B	Stitch Regulating Stud Cap (screw No. 22768)	20
51236 C	Feed Crank Stud (nut No. 269)	20
51240 A	Looper Connecting Rod, adjusting section, for styles in Classes 51200, 51300, 51400, 51500, 51900.	25
‡51241	Looper Connecting Rod, jointed section and ball joint assembly, right, for styles in Classes 51200, 51300, 51400, 51500, 51900 (ball stud washer No. 36 G, bearing screw No. 97 A)	40
‡51241 D	Looper Connecting Rod Ball Joint Assembly, left, for styles in Classes 51200, 51300, 51400, 51500, 51900 (bearing screw No. 97 A)	28
‡51242 A	Looper Driver Lever Shaft, 4 9/16 inches long, with bushing (screw No. 22597 A).	34
51242 C	Looper Driver Lever Shaft Bushing, rear (spot screw No. 96)	26
51242 E	Looper Drive Lever, lynite, for styles in Classes 51200, 51300, 51400, 51500, 51700, 51900	40
51242 F	Looper Drive Lever Barrel Clamp, for Styles 51200 A, 51200 G, 51200 H, 51900 B, 51900 C	25
51243 B	Looper Drive Lever Ball Stud; also for No. 51215 A (set screw, hexagonal head, No. 22519).	28
51243 C	Looper Drive Lever Ball Stud Guide Fork; also for No. 51243 B (screw No. 97).	28
51243 E	Looper Drive Lever Connection Felt Retainer	29
‡51243 J	Looper Drive Eccentric Guard, for styles 51200 A, 51200 G, 51200 H, 51900 B, 51900 C (screw No. 94).	46

LIST OF PARTS

Symbol to Order by	The figures in the last column refer only to the plates illustrating the parts and are not to be used in ordering. Refer to pink insert for prices.	Plate No.
51243 K	Looper Drive Eccentric Oil Disc (screw No. 22716)	37
51243 L	Looper Drive Eccentric Oil Disc Gasket.	37
51243 N	Looper Drive Eccentric Oil Disc Washer, steel (screw No. 22716 A)	37
51243 R	Looper Drive Eccentric Felt Retainer.	29
51244	Looper Rocker Frame, for styles in Classes 51200, 51300, 51400, 51500, 51900 (spot screw No. 96, set screw No. 98)	40
51244 A	Looper Rock Shaft, for styles in Classes 51200, 51300, 51400, 51500, 51700, 51900.	35
51244 B	Looper Rock Shaft Arm (clamp screw No. 93).	28
51244 C	Looper Rock Shaft Sleeve, for styles in Classes 51200, 51300, 51500, 51900, Styles 51400 A, 51400 B, 51400 C, 51400 D, 51400 E, 51400 F, 51400 H, 51400 J, 51400 K, 51400 L, 51400 M, 51400 N (screw No. 88 B)	26
51244 E	Looper Rock Shaft Bushing	26
51245	Looper Avoid Eccentric Link and Feed Lift Eccentric Link (shim No. 51245 A, screw No. 22569, nut No. 7947).	28
51245 A	Looper Avoid Eccentric Link Oil Retaining Pad	29
51246	Looper Rocker Stud Nut, for styles in Classes 51200, 51300, 51400, 51500, 51900	19
51250	Needle Lever Stud (screw No. 719)	34
51250 B	" " Thrust Collar (screw No. 719).	26
51250 C	" " Link Pin Clamp Screw Nut, for styles in Classes 51400, 51700	19
51251	Needle Thread Controller Lever Assembly, for Styles 51200 A, 51200 G, 51200 H, 51900 B, 51900 C	38
51252	Presser Bar Guide and Thread Controller Rack, for Styles 51200 A, 51200 G, 51200 H, 51900 B, 51900 C (screw No. 531).	34
51254	Needle Bar Bushing, upper	26
51254 A	" " " lower	26
51256 A	Presser Spring, upper, for machines equipped with internal presser spring.	44
51256 B	Presser Spring, lower, for machines equipped with internal presser spring.	44
51257	Presser Bar, for machines equipped with internal presser spring	35
51257 A	Presser Bar Bushing, upper, length over all 2 1/8 inches, for machines equipped with internal presser spring	26
51257 C	Presser Bar Bushing, lower, length over all 1 3/4 inches.	34

LIST OF PARTS

Symbol to Order by	The figures in the last column refer only to the plates illustrating the parts and are not to be used in ordering. Refer to pink insert for prices.	Plate No.
51258	Needle Lever Thread Eyelet, for styles in Classes 51200, 51300 (screw No. 22768)	23
51258 A	Needle Bar Thread Eyelet, for styles in Classes 51200, 51300 (screw No. 22768)	23
51260	Parallel Take-up Thread Eyelet, front, for Styles 51200 A, 51200 G, 51200 H (screw No. 87 U)	23
51260 A	Parallel Take-up Thread Eyelet, rear, for Styles 51200 A, 51200 G, 51200 H (screw No. 87 U)	23
51270 A	Needle Thread Take-up, for Styles 51200 G, 51200 H, 51900 B, 51900 C (screw No. 90)	38
51270 B	Needle Thread Take-up, for styles in Classes 51300, 51500, 51700, Styles 51200 B, 51200 C, 51200 J, 51400 A, 51400 B, 51400 C, 51400 D, 51400 E, 51400 F, 51400 H, 51400 J, 51400 K, 51400 L, 51400 M, 51400 N, 51900 A (screw No. 90)	38
51280 A	Throat Plate Support, for Styles 51200 C, 51200 G, 51200 H, 51200 J, 51300 A, 51300 C, 51300 D, 51400 H, 51400 J, 51500 D, 51700 F using throat plates 2 1/4 inches long (screw No. 80)	46
51280 B	Throat Plate Support, for Style 51700 E (screw No. 22839)	46
51280 G	Throat Plate Support, for Style 51400 G (screw No. 80)	46
51280 K	Dowel Pin, for main shaft oil gauge assem- bly.	25
51281-204	Cloth Plate Cover, 6 17/64 inches long, not drilled for attachments, for Styles 51700 E, 51700 F	46
51281-206	Cloth Plate Cover, 6 27/64 inches long, for styles in Class 54100.	46
51281-216	Cloth Plate Cover, 6 3/4 inches long, for Styles 51200 J, 51400 C, 51400 D, 51400 M, 51700 C, 51700 D, 51700 E	46
51281-226	Cloth Plate Cover, 7 1/16 inches long, for Styles 51300 B, 51400 B, 51400 F, 51400 L, 51400 N, 51500 A, 51500 C, 51500 G, 51900 B, 51900 C.	46
51281-228	Cloth Plate Cover, 7 1/8 inches long, for Styles 51200 C, 51400 H, 51500 D; also No. 18 gauge Style 51400 G	46
51281-230	Cloth Plate Cover, 7 3/16 inches long, for No. 24 gauge Style 51400 G	46
51281-232	Cloth Plate Cover, 7 1/4 inches long, for No. 16 gauge Style 51400 G	46

LIST OF PARTS

Symbol to Order by	The figures in the last column refer only to the plates illustrating the parts and are not to be used in ordering. Refer to pink insert for prices.	Plate No.
51281-233	Cloth Plate Cover, 7 9/32 inches long, for Styles 51200 G, 51200 H, 51300 A, 51300 C, 51300 D, 51400 H, 51400 J	46
51281 C-226	Cloth Plate Cover, 7 1/16 inches long, for Styles 51200 A, 51200 B	46
51281 F	Cloth Plate Cover Spring (screw No. 22726 A).	43
51282	Louver Cover (screw No. 90)	44
51282 B	Face Plate (thumbscrew No. 22837)	44
51282 C	Crank Chamber Cover, for Styles 51200 A, 51200 G, 51200 H, 51400 G, 51900 B, 51900 C (screw No. 22524)	44
51282 H	Crank Chamber Cover Gasket.	44
‡51282 J	Crank Chamber Oil Reservoir, including tubes and sight gauge No. 39193, for styles in Classes 51300, 51500, 51700, 54100, Styles 51200 A, 51200 G, 51200 H, 51400 A, 51400 B, 51400 C, 51400 D, 51400 E, 51400 F, 51400 H, 51400 J, 51400 K, 51400 L, 51400 M, 51400 N, 51900 A (attaching screw, right, No. 22849, attaching screw, left, No. 35768 A).	46
51283	Lifter Lever (stud No. 22566 A)	52
51283 A	Lifter Lever Spring	21
51283 B	Lifter Lever Spring Pin	25
51283 C	Presser Bar Lifter Bracket, for Styles 51200 A, 51200 G, 51200 H, 51400 G, 51900 B, 51900 C.	28
51290	Main Shaft Bushing, inner, left, 3/4 inch long; also middle bushing on Styles 51200 A, 51200 G, 51200 H, 51400 G, 51900 B, 51900 C.	26
51290 A	Main Shaft Bushing, outer, right, 1 9/32 inches long	26
51290 D	Main Shaft Bushing, left, 3/4 inch long	26
51290 E	Main Shaft Bushing, middle, for styles in Classes 51300, 51500, 51700, 54100, Styles 51200 B, 51200 C, 51200 J, 51400 A, 51400 B, 51400 C, 51400 D, 51400 E, 51400 F, 51400 H, 51400 J, 51400 K, 51400 L, 51400 M, 51400 N, 51900 A	26
‡51290 N	Main Shaft Bushing Housing, includes bushing	47

LIST OF PARTS

Symbol to Order by	The figures in the last column refer only to the plates illustrating the parts and are not to be used in ordering. Refer to pink insert for prices.	Plate No.
51291	Looper Thread Guard, for styles in Class 51700, Styles 51200 A, 51200 G, 51200 H, 51900 B, 51900 C (screw No. 22711). . . .	44
51292	Tension Post.	24
51292 A	" " Ferrule.	24
51292 C	" Regulating Nut.	19
51292 D	Needle Thread Tension Eyelet, also looper thread tension eyelet on styles in Classes 51300, 51500, Styles 51200 B, 51200 C, 51200 J	23
51292 E	Looper Thread Tension Eyelet, for styles in Class 51700, Styles 51200 A, 51200 G, 51200 H, 51400 G, 51900 B, 51900 C. . . .	23
51292 F-1	Tension Spring, .016 inch diameter wire, for looper threads.	21
51292 F-2	Tension Spring, .022 inch diameter wire, for looper threads.	21
51292 F-4	Tension Spring, .026 inch diameter wire, for needle threads.	21
51292 F-5	Tension Spring, .031 inch diameter wire, for needle threads.	21
51292 F-8	Tension Spring, .037 inch diameter wire, for needle threads.	21
51292 F-14	Tension Spring, .047 inch diameter wire, for needle threads.	21
51293	Crank Chamber Oil Gauge, for Styles 51200 A, 51200 G, 51200 H, 51400 G, 51900 B, 51900 C (screw No. 97)	48
51293 A	Crank Chamber Oil Tube, for outer right main shaft bearing.	37
51293 B	Crank Chamber Oil Tube Clamp (screw No. 22769).	29
51293 K	Crank Chamber Oil Tube, for inner left main shaft bearing on Styles 51700 C, 51700 D, 51700 E, 51700 G, 51700 H, 54100 D, 54100 E	-
51293 L	Main Shaft Bearing Oil Tube, for Style 51400 G	37
51294 A	Oil Drain Clamp Spring.	48
51295	Isolated Insulators, for "II" installation	29
51296	Machine Base Dowel Pin, front	29
51296 A	" " " " rear.	29
51301 A	Cloth Plate, for Styles 51200 C, 51200 J, 51300 A, 51300 C, 51300 D, 51400 H, 51400 J, 51500 D, using throat plates 2 1/4 inches long (screw No.-80).	54
51305 A	Feed Dog, for Styles 51300 A, 51300 C	7
51305 B	" " for Style 51300 B	8
	" " Screw No. 22528	

Sugar!

S

32
7
229

LIST OF PARTS

Symbol to Order by	The figures in the last column refer only to the plates illustrating the parts and are not to be used in ordering. Refer to pink insert for prices.	Plate No.
51320 B	Presser Foot Assembly, for Style 51300 B; one each Nos. 51330 B, 65 XD, 86 X and two No. 88	11
51320 C	Presser Foot Assembly, for Style 51300 C; one each Nos. 51330 C, 91, 22799 B, 51530 A.	10
51321 A	Pulley, working diameter 2 1/2 inches, for styles in Classes 51300, 51500, 51400, Styles 51200 B, 51200 C, 51200 J, 51700 F, 51900 B, 51900 C (spot screw No. 22597, set screw No. 22597 A).	39
‡51322 B	Crankshaft Assembly, for styles in Classes 51300, 51500, Styles 51700 F, 51900 B, 51900 C; includes crankshaft No. 51322 A (bearing screw No. 75 A)	49
51324 B	Throat Plate, for Style 51300 B (screw No. 22570)	5
51330 B	Presser Foot Bottom, for Style 51300 B	—
51330 C	" " " for Style 51300 C	—
‡51394	Main Oil Reservoir, for Styles 51300 D, 51500 D (screw No. 93)	52
K51396	Table Board, 48" x 16" x 1 3/4", for non- submerged group installation of styles in Classes 51200, 51300, 51400, 51500, 51700, 51900, 51400, equipped with Class 21700 Puller	—
51401	Cloth Plate, for Styles 51400 A, 51400 E, 51400 K, 51900 A, using throat plates 3 1/8 inches long.	54
51401 C	Puller Cloth Plate, for Style 51400 G (screw No. 22839).	46
51401 H	Cloth Plate, for Style 51400 G using throat plates 2 1/4 inches long (screw No. 80).	54
51402	Cloth Plate Slide, front, for Styles 51400 A, 51400 E, 51400 K, 51900 A.	48
51404	Parallel Take-up Cast-off, for styles in Class 51700, Styles 51200 A, 51200 G, 51200 H, 51400 G, 51900 B, 51900 C (screw No. 22833)	27
51405-8	Feed Dog, with feed surface between needles, for Nos. 8, 10 and 12 gauge double lap seam felling machines in Class 51400	7
51405-16	Feed Dog, for Nos. 16 and 18 gauge Style 51400 A.	7

LIST OF PARTS

Symbol to Order by	The figures in the last column refer only to the plates illustrating the parts and are not to be used in ordering. Refer to pink insert for prices.	Plate No.
51405 A-8	Feed Dog, for Nos. 6 and 8 gauge Style	
	51400 A	9
51405 A-10	" " for Nos. 10 and 12 gauge Style	
	51400 A	9
51405 B-32	" " for No. 32 gauge Style 51400 D. .	9
51405 B-48	" " for No. 48 gauge Styles 51400 B, 51400 D	9
51405 C-48	" " for No. 48 gauge Styles 51400 C, 51400 M, 51400 N.	9
51405 E-8	" " for Nos. 8, 10 and 12 gauge Style 51400 E	7
51405 E-16	" " for No. 16 gauge Style 51400 E. .	7
51405 F-32	" " for No. 32 gauge Styles 51400 F, 51400 L	9
51405 K-26	" " for No. 26 gauge Style 51400 K. .	7
	" " Screw No. 22528	
51408-6	Looper, front, for No. 6 gauge Style	
	51400 A	13
51408-8	" front, for No. 8 gauge Styles	
	51400 A, 51400 E.	13
51408-10	" front, for No. 10 gauge Styles	
	51400 A, 51400 E.	13
51408-12	" front, for No. 12 gauge Styles	
	51400 A, 51400 E.	13
51408-16	" front, for No. 16 gauge Styles	
	51400 A, 51400 E, 51400 G	13
51408-18	" front, for No. 18 gauge Styles	
	51400 A, 51400 G.	13
51408-24	" front, for No. 24 gauge Styles	
	51400 G, 51400 K.	13
51408-26	" front, for No. 26 gauge Styles	
	51400 J, 51400 K.	13
51408-32	" front, for No. 32 gauge Styles	
	51400 D, 51400 F, 51400 L	13
51408-48	" front, for No. 48 gauge Styles	
	51400 B, 51400 C, 51400 D, 51400 M, 51400 N	13
51408 A-16	" front, for No. 16 gauge Style	
	51400 H	13
51409	" for Styles 51200 A, 51200 G; also back looper for Styles 51400 A, 51400 E, 51400 G, 51400 J, 51400 K, and middle looper for Style	
	51900 A	13
51409 B	" back, for Styles 51400 B, 51400 C, 51400 D, 51400 F, 51400 L, 51400 M, 51400 N	13
	" Set Screw No. 73	

LIST OF PARTS

Symbol to Order by	The figures in the last column refer only to the plates illustrating the parts and are not to be used in ordering. Refer to pink insert for prices.	Plate No.
51413	Looper Rocker, for Styles 51400 A, 51400 B, 51400 C, 51400 D, 51400 E, 51400 F, 51400 K, 51400 L, 51400 M, 51400 N	40
51417-6	Needle Bar, for No. 6 gauge Style 51400 A	36
51417-8	" " for No. 8 gauge Styles 51400 A, 51400 E	36
51417-10	" " for No. 10 gauge Styles 51400 A, 51400 E.	36
51417-12	" " for No. 12 gauge Styles 51400 A, 51400 E.	36
51417-16	" " for No. 16 gauge Styles 51400 A, 51400 E.	36
51417-18	" " for No. 18 gauge Style 51400 A	36
51417 B	Needle Bar, for Styles 51400 B, 51400 C, 51400 D, 51400 F, 51400 J, 51400 K, 51400 L, 51400 M, 51400 N, 51500 D; also No. 24 gauge Style 51400 G.	36
51418-16	Needle Bar Set Screw No. 88 A Needle Holder, marked "D-16", for Styles 51400 A, 51400 E; also for No. 16 gauge Styles 51400 G, 51400 H, 51500 A.	22
51418 B-32	Needle Holder, marked "D-32", for No. 32 gauge Styles 51400 D, 51400 F, 51400 L.	22
51418 B-48	Needle Holder, marked "D-48", for No. 48 gauge Styles 51400 B, 51400 C, 51400 D, 51400 M, 51400 N.	22
51418 K-24	Needle Holder, marked "L-24", for No. 24 gauge Style 51400 K	22
51418 K-26	Needle Holder, marked "L-26", for No. 26 gauge Style 51400 K	22
51420-6	Needle Holder Spot Screw No. 89 " " Set Screw No. 98 Presser Foot Assembly, for No. 6 gauge Style 51400 A; one each Nos. 51430 A-6, 91, 22799 B, 51430 B.	10
51420-8	Presser Foot Assembly, for No. 8 gauge; one each Nos. 51430 A-8, 91, 22799 B, 51430 B	10
51420-10	Presser Foot Assembly, for No. 10 gauge; one each Nos. 51430 A-10, 91, 22799 B, 51430 B	10
51420-12	Presser Foot Assembly, for No. 12 gauge; one each Nos. 51430 A-12, 91, 22799 B, 51430 B	10
51420-16	Presser Foot Assembly, for No. 16 gauge; one each Nos. 51430 A-16, 91, 22799 B, 51430 B	10

LIST OF PARTS

Symbol to Order by	The figures in the last column refer only to the plates illustrating the parts and are not to be used in ordering. Refer to pink insert for prices.	Plate No.
51420-18	Presser Foot Assembly, for No. 18 gauge; one each Nos. 51430 A-18, 91, 22799 B, 51430 B	10
51420 C-32	Presser Foot Assembly, for No. 32 gauge Styles 51400 D, 51400 F; one each Nos. 51430 C-32, 77, 91, 22752 B, 51430.	10
51420 C-48	Presser Foot Assembly, for No. 48 gauge Styles 51400 B, 51400 C, 51400 D, 51400 N; one each Nos. 51430 C-48, 77, 91, 22752 B, 51430.	10
51420 E-8	Presser Foot Assembly, for No. 8 gauge Style 51400 E; one each Nos. 51430 E-8, 91, 22799 B, 22840 A, 51430 D, 51430 F.	11
51420 E-10	Presser Foot Assembly, for No. 10 gauge; one each Nos. 51430 E-10, 91, 22799 B, 22840 A, 51430 D, 51430 F	11
51420 E-12	Presser Foot Assembly, for No. 12 gauge; one each Nos. 51430 E-12, 91, 22799 B, 22840 A, 51430 D, 51430 F	11
51420 E-16	Presser Foot Assembly, for No. 16 gauge; one each Nos. 51430 E-16, 91, 22799 B, 22840 A, 51430 D, 51430 F	11
51420 K-26	Presser Foot Assembly, for No. 26 gauge Style 51400 K; one each Nos. 51430 K-26, 22799 B, 51430 B.	10
51420 L-32	Presser Foot, for No. 32 gauge Style 51400 L (set screw No. 88).	31
51420 M-48	Presser Foot Assembly, for No. 48 gauge Style 51400 M; one each Nos. 51430 M-48, 97, 605 A, 16194, 51430 G, 51430 H, 51430 N-48; two each Nos. 88, 91 A; three No. 605	11
51422 B	Crankshaft Assembly, for styles in Class 51400, Styles 51200 A, 51200 G, 51200 H, 51700 C, 51700 D, 51700 E, 51900 A; includes crankshaft No. 51422 A (bearing screw No. 75 A)	49
51423	Parallel Take-up, for Styles 51200 A, 51200 G, 51200 H, 51400 G, 51900 B, 51900 C	38
51423 B	Shielded Disc Take-up, for Styles 51200 B, 51200 C, 51200 J, 51400 A, 51400 B, 51400 C, 51400 D, 51400 E, 51400 F, 51400 H, 51400 J, 51400 K, 51400 L, 51400 M, 51400 N, 51900 A (spot screw No. 96, set screw No. 22580).	38

LIST OF PARTS

Symbol to Order by	The figures in the last column refer only to the plates illustrating the parts and are not to be used in ordering. Refer to pink insert for prices.	Plate No.
51424-16	Throat Plate, for No. 16 gauge Style 51400 A	2
51424-18	" " for No. 18 gauge.	2
51424 A-6	" " for No. 6 gauge Style 51400 A	3
51424 A-8	" " for No. 8 gauge	3
51424 A-10	" " for No. 10 gauge.	3
51424 A-12	" " for No. 12 gauge.	3
51424 B-32	" " for No. 32 gauge Style 51400 D	1
51424 B-48	" " for No. 48 gauge Styles 51400 B, 51400 D.	1
51424 C-48	" " for No. 48 gauge Styles 51400 C, 51400 M, 51400 N	1
51424 E-8	" " for No. 8 gauge Style 51400 E	3
51424 E-10	" " for No. 10 gauge.	3
51424 E-12	" " for No. 12 gauge.	3
51424 E-16	" " for No. 16 gauge.	3
51424 F-32	" " for No. 32 gauge Styles 51400 F, 51400 L.	3
51424 K-26	" " for No. 26 gauge Style 51400 K	3
	" " Screw No. 22570	3
51425	Needle Guard, for Styles 51400 A, 51400 B, 51400 C, 51400 D, 51400 E, 51400 F, 51400 K, 51400 L, 51400 M, 51400 N (screw No. 22585 B, washer No. 39236 A).	14
51428-8	Throat Plate, with feed surface between needles, for No. 8 gauge double lap seam felling machines in Class 51400 (feed dog No. 51405-8).	2
51428-10	Throat Plate, for No. 10 gauge (feed dog No. 51405-8).	2
51428-12	" " for No. 12 gauge (feed dog No. 51405-8).	2
	" " Screw No. 22570	
51430	Presser Foot Shank, for Styles 51400 B, 51400 C, 51400 D, 51400 F, 51400 N, 51700 C, 51700 D.	—
51430 A-6	Presser Foot Bottom, for No. 6 gauge Style 51400 A.	—
51430 A-8	" " " for No. 8 gauge.	—
51430 A-10	" " " for No. 10 gauge	—
51430 A-12	" " " for No. 12 gauge	—
51430 A-16	" " " for No. 16 gauge	—
51430 A-18	" " " for No. 18 gauge	—
51430 B	" " Shank, for Styles 51400 A, 51400 K.	—

LIST OF PARTS

Symbol to Order by	The figures in the last column refer only to the plates illustrating the parts and are not to be used in ordering. Refer to pink insert for prices.	Plate No.
51430 C-32	Presser Foot Bottom, for No. 32 gauge Styles 51400 D, 51400 F.	—
51430 C-48	Presser Foot Bottom, for No. 48 gauge Styles 51400 B, 51400 C, 51400 D, 51400 N.	—
51430 D	Presser Foot Shank, for Style 51400 E. . .	—
51430 E-8	" " Bottom, for No. 8 gauge Style 51400 E.	—
51430 E-10	" " Bottom, for No. 10 gauge. . .	—
51430 E-12	" " " for No. 12 gauge. . .	—
51430 E-16	" " " for No. 16 gauge. . .	—
51430 F	Presser Foot Regulating Screw Lock Nut, for Styles 51200 B, 51200 C, 51400 E. . .	19
51430 G	Presser Foot Shank, for Style 51400 M. . .	—
51430 H	" " Yielding Section Spring Holder, for Style 51400 M. . .	—
51430 K-26	" " Bottom, for No. 26 gauge Style 51400 K.	—
51430 M-48	" " " for No. 48 gauge Style 51400 M.	—
51430 N-48	" " Yielding Section, for No. 48 gauge Style 51400 M.	—
51443 G	Looper Drive Eccentric Guard, for Style 51400 G (screw No. 94).	46
51457	Cast-off Plate Support, for Styles 51400 A, 51400 B, 51400 C, 51400 D, 51400 E, 51400 F, 51400 H, 51400 J, 51400 K, 51400 L, 51400 M, 51400 N, 51900 A (screw No. 22528).	38
51458	Needle Lever Thread Eyelet, for styles in Classes 51400, 51500, 51700 (screw No. 22768).	23
51458 A	Needle Bar Thread Eyelet, for styles in Classes 51400, 51500, 51700 (screw No. 22768).	23
51459 A	Looper Thread Tension Post Thread Guide, for Styles 51400 A, 51400 B, 51400 C, 51400 D, 51400 E, 51400 F, 51400 H, 51400 J, 51400 K, 51400 L, 51400 M, 51400 N.	23
51460	Parallel Take-up Thread Eyelet, front, for styles in Class 51700, Style 51400 G (screw No. 87 U).	23
51460 A	Parallel Take-up Thread Eyelet, rear, (screw No. 87 U).	23
51461	Parallel Take-up Flange, left, for styles in Class 51700, Styles 51200 A, 51200 G, 51200 H, 51400 G (screw No. 22794 B).	39

LIST OF PARTS

Symbol to Order by	The figures in the last column refer only to the plates illustrating the parts and are not to be used in ordering. Refer to pink insert for prices.	Plate No.
51461 A	Parallel Take-up Flange, right (set screw No. 89, spot screw No. 22764 A)	39
51461 B	Parallel Take-up Block.	24
51461 C	" " Sleeve	25
51462	" " Eyelet Stand (screw No.79)	40
51462 A	" " " Stud.	18
51462 B	" " " Support (screw No. 22560 B).	24
51462 C	" " " Stand Pin	34
51477	Fuller Frame, for Style 51400 G (screw No. 22788).	—
51480	Throat Plate Support, for Styles 51200 A, 51200 B, 51300 B, 51400 A, 51400 B, 51400 C, 51400 D, 51400 E, 51400 F, 51400 K, 51400 L, 51400 M, 51400 N, 51500 A, 51500 C, 51500 G, 51700 C, 51700 D, 51900 A, 51900 B, 51900 C, using throat plates 3 1/8 inches long (screw No. 22839).	46
51482 A	Looper Mechanism Guard, for Style 51400 G (screw No. 25 S).	46
51482 B	Cloth Plate End Cover, for Style 51400 G.	54
51491	Looper Thread Guide Wire, for Styles 51400 A, 51400 B, 51400 C, 51400 D, 51400 E, 51400 F, 51400 H, 51400 J, 51400 K, 51400 L, 51400 M, 51400 N (screw No. 87 U).	38
51491 A	Looper Thread Guard, for styles in Classes 51300, 51500, Styles 51200 B, 51200 C, 51200 J, 51400 A, 51400 B, 51400 C, 51400 D, 51400 E, 51400 F, 51400 H, 51400 J, 51400 K, 51400 L, 51400 M, 51400 N (screw No. 22848)	44
51491 B-4	Thread Lead-in Guide, for Styles 51400 A, 51400 B, 51400 C, 51400 D, 51400 E, 51400 F, 51400 H, 51400 J, 51400 K, 51400 L, 51400 M, 51400 N (screw No. 94)	48
51492	Tension Post, for Styles 51400 A, 51400 B, 51400 C, 51400 D, 51400 E, 51400 F, 51400 H, 51400 J, 51400 K, 51400 L, 51400 M, 51400 N.	24
51494	Main Oil Reservoir, for Styles 51200 B, 51200 C, 51200 J, 51300 A, 51300 B, 51300 C, 51400 A, 51400 B, 51400 C, 51400 D, 51400 E, 51400 F, 51400 H, 51400 J, 51400 K, 51400 L, 51400 M, 51400 N, 51500 A, 51500 C, 51500 G, 51900 A (screw No. 93).	52

LIST OF PARTS

Symbol to Order by	The figures in the last column refer only to the plates illustrating the parts and are not to be used in ordering. Refer to pink insert for prices.	Plate No.
51505-18	Feed Dog, for Nos. 16 and 18 gauge Style 51500 A.	7
51505 C-1	" " for No. 1 gauge Style 51500 C.	8
51505 G-1	" " for No. 1 gauge Style 51500 G.	8
	" " Screw No. 22528	
51508-16	Looper, front, for No. 16 gauge Style 51500 A.	13
51508-18	" front, for No. 18 gauge.	13
51508 C-1	" front, for No. 1 gauge Style 51500 C.	13
51508 G-1	" front, for No. 1 gauge Style 51500 G.	13
51509 C	" back, for Styles 51500 C, 51500 G.	13
	" Set Screw No. 73	
51513	" Rocker, for styles in Class 51500.	40
51517-16	Needle Bar, for No. 16 gauge Styles 51400 G, 51400 H, 51500 A.	36
51517 A	Needle Bar, for Nos. 18 and 24 gauge Style 51400 G; also No. 18 gauge Style 51500 A.	36
51517 G-1	Needle Bar, for No. 1 gauge Style 51500 G.	36
	Needle Bar Set Screw No. 88 A	
51518 G-1	Needle Holder, for No. 1 gauge Style 51500 G (clamp screw No. 89, needle set screw No. 88 B, needle clamp screw No. 22729).	22
51520-16	Presser Foot Assembly, for No. 16 gauge Style 51500 A; one each Nos. 51530-16, 22799 C, 35830, 51930.	10
51520-18	Presser Foot Assembly, for No. 18 gauge Style 51500 A; one each Nos. 51530-18, 22799 C, 35830, 51930.	10
51520 C-1	Presser Foot Assembly, for No. 1 gauge Styles 51500 C, 51500 G; one each Nos. 51530 C-1, 1740, 22799 C, 51530 D, 51530 E, 51530 F, 51530 G.	11
51523 C	Shielded Disc Take-up, for styles in Classes 51300, 51500 (spot screw No. 96, set screw No. 22580)	38
51524-16	Throat Plate, for No. 16 gauge Style 51500 A.	2
51524-18	" " for No. 18 gauge	2
51524 C-1	" " for No. 1 gauge Style 51500 C.	3
51524 G-1	" " for No. 1 gauge Style 51500 G.	3
	" " Screw No. 22570	
51525	Needle Guard, for Styles 51400 G, 51400 J, 51500 A, 51500 D.	14
51525 C	" " for Style 51500 C.	14
51525 G	" " for Style 51500 G.	14
	" " Screw No. 22585 B	
	" " Washer No. 39236 A	
51530-16	Presser Foot Bottom, for No. 16 gauge Style 51500 A.	—

LIST OF PARTS

Symbol to Order by	The figures in the last column refer only to the plates illustrating the parts and are not to be used in ordering. Refer to pink insert for prices.	Plate No.
51530-18	Presser Foot Bottom, for No. 18 gauge. . .	—
51530 A	" " Shank, for Style 51300 C. . .	—
51530 C-1	" " Bottom, for Styles 51500 C, 51500 G	—
51530 D	" " Shank, for Styles 51500 C, 51500 G	—
51530 E	" " Yielding Section, for Styles 51500 C, 51500 G.	—
51530 F	" " Yielding Section Plunger, for Styles 51500 C, 51500 G . . .	12
51530 G	" " Yielding Section Spring, for Styles 51500 C, 51500 G . . .	21
51701 C	Cloth Plate, for Styles 51400 B, 51400 C, 51400 D, 51400 M, 51400 N; also Nos. 56 and 64 gauge Styles 51700 C, 51700 D (screw No. 80)	54
51701 F	Cloth Plate, for Style 51700 E (screw No. 80).	54
51705-56	Feed Dog, for No. 56 gauge Style 51700 C	9
51705-64	" " for No. 64 gauge	9
51705-72	" " for No. 72 gauge	9
51705-80	" " for No. 80 gauge	9
51705-96	" " for No. 96 gauge	9
51705-112	" " for No. 112 gauge.	9
51705 D-56	" " for No. 56 gauge Style 51700 D	9
51705 D-64	" " for No. 64 gauge	9
51705 D-72	" " for No. 72 gauge	9
51705 D-80	" " for No. 80 gauge	9
51705 D-96	" " for No. 96 gauge	9
51705 D-112	" " for No. 112 gauge.	9
51705 E-64	" " for No. 64 gauge Style 51700 E	9
51705 E-72	" " for No. 72 gauge	9
51705 E-80	" " for No. 80 gauge	9
	" " Screw No. 22528	
51708	Looper, right, for styles in Class 51700	13
51709	" left, for styles in Class 51700. .	13
	" Set Screw No. 73	
51713	" Rocker, for styles in Class 51700	40
51717	Needle Bar, for styles in Classes 51700, 51400 (set screw No. 88 A)	36
51720-56	Presser Foot Assembly, for No. 56 gauge Style 51700 C; one each Nos. 51730-56, 77, 22752 B, 22799 D, 51430, 51730 A-56 and two No. 91 A	10
51720-64	Presser Foot Assembly, for No. 64 gauge; one each Nos. 51730-64, 77, 22752 B, 22799 D, 51430, 51730 A-64 and two No. 91 A	10

LIST OF PARTS

Symbol to Order by	The figures in the last column refer only to the plates illustrating the parts and are not to be used in ordering. Refer to pink insert for prices.	Plate No.
51720-72	Presser Foot Assembly, for No. 72 gauge; one each Nos. 51730-72, 77, 22752 B, 22799 D, 51430, 51730 A-72 and two No. 91 A.	10
51720-80	Presser Foot Assembly, for No. 80 gauge; one each Nos. 51730-80, 77, 22752 B, 22799 D, 51430, 51730 A-80 and two No. 91 A.	10
51720-96	Presser Foot Assembly, for No. 96 gauge; one each Nos. 51730-96, 77, 22752 B, 22799 D, 51430, 51730 A-96 and two No. 91 A.	10
51720-112	Presser Foot Assembly, for No. 112 gauge; one each Nos. 51730-112, 77, 22752 B, 22799 D, 51430, 51730 A-112 and two No. 91 A.	10
51720 D-56	Presser Foot Assembly, for No. 56 gauge Style 51700 D; one each Nos. 51730 D-56, 77, 22752 B, 22799 D, 51430	10
51720 D-64	Presser Foot Assembly, for No. 64 gauge; one each Nos. 51730 D-64, 77, 22752 B, 22799 D, 51430.	10
51720 D-72	Presser Foot Assembly, for No. 72 gauge; one each Nos. 51730 D-72, 77, 22752 B, 22799 D, 51430.	10
51720 D-80	Presser Foot Assembly, for No. 80 gauge; one each Nos. 51730 D-80, 77, 22752 B, 22799 D, 51430.	10
51720 D-96	Presser Foot Assembly, for No. 96 gauge; one each Nos. 51730 D-96, 77, 22752 B, 22799 D, 51430.	10
51720 D-112	Presser Foot Assembly, for No. 112 gauge; one each Nos. 51730 D-112, 77, 22752 B, 22799 D, 51430.	10
51720 E-72	Presser Foot Assembly, for No. 72 gauge Style 51700 E; one each Nos. 51730 E-72, 605, 8040, 51730 F-72, two No. 88 and three No. 605 A	11
51720 E-80	Presser Foot Assembly, for No. 80 gauge; one each Nos. 51730 E-80, 605, 8040, 51730 F-80, two No. 88 and three No. 605 A	11
51724-56	Throat Plate, for No. 56 gauge Style 51700 C	1
51724-64	" " for No. 64 gauge.	1
51724-72	" " for No. 72 gauge.	1
51724-80	" " for No. 80 gauge.	1
51724-96	" " for No. 96 gauge.	1

LIST OF PARTS

Symbol to Order by	The figures in the last column refer only to the plates illustrating the parts and are not to be used in ordering. Refer to pink insert for prices.	plate No.
51724-112	Throat Plate, for No. 112 gauge	1
51724 D-56	" " for No. 56 gauge Style 51700 D.	1
51724 D-64	" " for No. 64 gauge	1
51724 D-72	" " for No. 72 gauge	1
51724 D-80	" " for No. 80 gauge	1
51724 D-96	" " for No. 96 gauge	1
51724 D-112	" " for No. 112 gauge.	1
51724 E-64	" " for No. 64 gauge Style 51700 E.	4
51724 E-72	" " for No. 72 gauge	4
51724 E-80	" " for No. 80 gauge	4
	" " Screw No. 22570	
51725	Needle Guard, for Nos. 56 to 96 gauge Styles 51700 C, 51700 D, 51700 F	14
51725 A	Needle Guard, for Nos. 96 to 112 gauges. .	14
51725 E	" " for Style 51700 E.	14
	" " Screw No. 22585 B	
	" " Washer No. 39236 A	
51730-56	Presser Foot Bottom, for No. 56 gauge Style 51700 C	—
51730-64	" " " for No. 64 gauge.	—
51730-72	" " " for No. 72 gauge.	—
51730-80	" " " for No. 80 gauge.	—
51730-96	" " " for No. 96 gauge.	—
51730-112	" " " for No. 112 gauge	—
51730 A-56	" " Flexible Toe, for No. 56 gauge Style 51700 C	12
51730 A-64	" " Flexible Toe, for No. 64 gauge	12
51730 A-72	" " Flexible Toe, for No. 72 gauge	12
51730 A-80	" " Flexible Toe, for No. 80 gauge	12
51730 A-96	" " Flexible Toe, for No. 96 gauge	12
51730 A-112	" " Flexible Toe, for No. 112 gauge	12
51730 D-56	" " Flexible Toe Screw No. 91 A Bottom, for No. 56 gauge Style 51700 D	—
51730 D-64	" " Bottom, for No. 64 gauge.	—
51730 D-72	" " " for No. 72 gauge.	—
51730 D-80	" " " for No. 80 gauge.	—
51730 D-96	" " " for No. 96 gauge.	—
51730 D-112	" " " for No. 112 gauge	—
51730 E-72	" " " for No. 72 gauge Style 51700 E	—

LIST OF PARTS

Symbol to Order by	The figures in the last column refer only to the plates illustrating the parts and are not to be used in ordering. Refer to pink insert for prices.	Plate No.
51730 E-80	Presser Foot Bottom, for No. 80 gauge.	—
51730 F-72	" " Yielding Section, for No. 72 gauge Style 51700 E	—
51730 F-80	" " Yielding Section, for No. 80 gauge	—
\$51741	Looper Connecting Rod Ball Joint Assembly, left, for styles in Class 51700 (screw No. 97 A).	28
\$51741 B	Looper Connecting Rod Ball Joint Assembly, right, for styles in Class 51700; also puller connecting rod ball joint assem- bly for Style 51400 G (screw No. 97 A)	28
\$51743 B	Main Oil Reservoir, for Styles 51700 C, 51700 D, 51700 E (screw No. 93).	52
\$51743 F	Main Oil Reservoir, for Style 51700 F (screw No. 93)	52
51743 G	Oil Line "L" Coupling, for inner right main shaft bearing on Styles 51300 D, 51500 D, 51700 F, 51700 G, 54100 B, 54100 C.	37
51744	Looper Rocker Frame, for Nos. 112 and narrower gauge styles in Class 51700	40
51744 A	Looper Rocker Frame, for No. 128 gauge	40
	" " " Spot Screw No. 96	
	" " " Set Screw No. 98	
51745	" " Cone Stud.	28
51751	Presser Bar Guide, for Style 51400 G (screw No. 22560 B).	28
51758	Frame Needle Thread Eyelet, intermediate (attaching screw No. 22848, adapter screw No. 22840, washer No. 20).	23
51758 A	Frame Needle Thread Guide, for styles in Classes 51300, 51500, 51700; also Styles 51400 A, 51400 B, 51400 C, 51400 D, 51400 E, 51400 F, 51400 H, 51400 J, 51400 K, 51400 L, 51400 M, 51400 N (screw No. 22730).	24
51759	Frame Looper Thread Eyelet, for Style 51700 F (screw No. 93 A)	23
51770-56	Looper Rocker Link, for No. 56 gauge styles in Class 51700.	28
51770-64	" " Link, for No. 64 gauge	28
51770-72	" " " for No. 72 gauge	28
51770-80	" " " for No. 80 gauge	28
51770-96	" " " for No. 96 gauge	28
51770-112	" " " for No. 112 gauge.	28
	" " " Screw No. 22757	
51771	" " " Bushing.	20

LIST OF PARTS

Symbol to Order by	The figures in the last column refer only to the plates illustrating the parts and are not to be used in ordering. Refer to pink insert for prices.	Plate No.
51772-56	Looper Rocker Spacing Plate, for Nos. 56 and 96 gauge styles in Class 51700.	40
51772-64	Looper Rocker Spacing Plate, for Nos. 64 and 104 gauge	40
51772-72	Looper Rocker Spacing Plate, for Nos. 72 and 112 gauge	40
51772-80	Looper Rocker Spacing Plate, for No. 80 gauge	40
51773	Looper Rocker Frame Spacing Collar, for styles in Class 51700	20
51774-64	Differential Feed Roll, upper, for No. 64 gauge Style 51700 E	30
51774-72	Differential Feed Roll, upper, for No. 72 gauge	30
51774-80	Differential Feed Roll, upper, for No. 80 gauge	30
51774 D	" " " Screw No. 22743 Shaft, for Style 51700 E	25
51774 H	" " " Link.	27
51774 L	" " " Yoke (screw No. 88)	30
51774 N	Differential Feed Roll Yoke Support (attach- ing screw No. 22581, stop screw No. 22797)	30
51774 P	Differential Feed Roll Yoke Support Bracket (attaching screw No. 93).	30
51774 T	Differential Feed Roll Yoke Spring (attaching screw No. 605 A).	22
51775	Differential Feed Intermediate Gear, for Style 51700 E	27
51775 A	Differential Feed Intermediate Gear Guard (screw No. 604)	30
51776	Differential Feed Roll, lower (screw No. 22565 C).	30
51777-72	Stripper Blade, for Nos. 64 and 72 gauge Style 51700 E (screw No. 22726 A)	30
51777-80	Stripper Blade, for No. 80 gauge (screw No. 22726 A).	30
51777 D	Lower Roll Shaft and Driving Pinion, for Style 51700 E	25
51777 H	Lower Roll Link	27
51777 L	Lower Roll Bracket (attaching screw No. 87)	30
51785	Spring, .024 inch diameter wire, for guide leading strip to feed dog on Style 51700 E (screw No. 22504, washer No. 8372 A).	21
51905-5	Feed Dog, for No. 5 gauge Style 51900 A	7
51905-7	" " for No. 7 gauge Style 51900 B	7

LIST OF PARTS

Symbol to Order by	The figures in the last column refer only to the plates illustrating the parts and are not to be used in ordering. Refer to pink insert for prices.	Plate No.
51905 A-7	Feed Dog, for Nos. 6 and 7 gauge Style 51900 A	8
51905 B-9	" " for Nos. 8 and 9 gauge Style 51900 B	7
51905 C-9	" " for No. 9 gauge Style 51900 C " " Screw No. 22528	9
51908-5	Looper, front, for No. 5 gauge Style 51900 A	13
51908-6	" front, for No. 6 gauge	13
51908-7	" front, for No. 7 gauge	13
51908 A-7	" front, for No. 7 gauge Style 51900 B	13
51908 A-8	" front, for No. 8 gauge	13
51908 A-9	" front, for No. 9 gauge Styles 51900 B, 51900 C	13
51909-5	" back, for No. 5 gauge Style 51900 A	13
51909-6	" back, for No. 6 gauge.	13
51909-7	" back, for No. 7 gauge.	13
51909 A-7	" back, for No. 7 gauge Style 51900 B	13
51909 A-8	" back, for No. 8 gauge.	13
51909 A-9	" back, for No. 9 gauge Styles 51900 B, 51900 C	13
51909 B	Looper, for Style 51200 B; also back looper for Styles 51500 A, 51500 C and middle looper for Styles 51900 B, 51900 C Looper Set Screw No. 73	13
51913	Looper Rocker, for styles in Class 51900	40
51917-5	Needle Bar, for No. 5 gauge Style 51900 A and No. 7 gauge Style 51900 B	36
51917-9	Needle Bar, for No. 9 gauge Styles 51900 B, 51900 C	36
51918-5	Needle Bar Set Screw No. 88 A Needle Holder, marked "E-5", for No. 5 gauge Style 51900 A	22
51918-6	Needle Holder, marked "E-6", for No. 6 gauge	22
51918-7	" " marked "E-7", for No. 7 gauge Styles 51900 A, 51900 B " " Spot Screw No. 89 " Set Screw, outer, No. 98 " " " middle, No. 22752 A	22
51920-5	Presser Foot Assembly, for No. 5 gauge Style 51900 A; one each Nos. 51930 B-5, 91, 12935 A, 22799 E, 51930, 51930 A	10
51920-6	Presser Foot Assembly, for No. 6 gauge; one each Nos. 51930 B-6, 91, 12935 A, 22799 E, 51930, 51930 A	10
51920-7	Presser Foot Assembly, for No. 7 gauge Styles 51900 A, 51900 B; one each Nos. 51930 B-7, 91, 12935 A, 22799 E, 51930, 51930 A	10

LIST OF PARTS

Symbol to Order by	The figures in the last column refer only to the plates illustrating the parts and are not to be used in ordering. Refer to pink insert for prices.	Plate No.
51924-5	Throat Plate, for No. 5 gauge Style 51900 A	2
51924-7	" " for No. 7 gauge Style 51900 B	2
51924 A-6	" " for No. 6 gauge Style 51900 A	2
51924 A-7	" " for No. 7 gauge Style 51900 A	2
51924 B-8	" " for No. 8 gauge Style 51900 B	2
51924 B-9	" " for No. 9 gauge	2
51924 C-9	" " for No. 9 gauge Style 51900 C	4
	" " Screw No. 22570	
51925	Needle Guard, for styles in Class 51900 (screw No. 22585 B, washer No. 39236 A) . .	14
51930	Presser Foot Tilting Spring, for Styles 51500 A, 51900 B	21
51930 A	" " Shank, for Style 51900 A	—
51930 B-5	" " Bottom, for No. 5 gauge Style 51900 A	—
51930 B-6	" " Bottom, for No. 6 gauge	—
51930 B-7	" " Bottom, for No. 7 gauge Styles 51900 A, 51900 B	—
51957	" Bar, for Style 51900 C	34
51958	Needle Lever Thread Eyelet, for styles in Class 51900 (screw No. 22768)	23
51958 A	Needle Bar Thread Eyelet, for styles in Class 51900 (screw No. 22768)	23
51958 B	Frame Needle Thread Eyelet, for Style 51900 A	23
51959	Looper Thread Nipper Support, for Styles 51200 A, 51200 G, 51200 H, 51400 G, 51900 B, 51900 C (screw No. 93 A)	24
51959 B	Looper Thread Nipper Disc, for styles in Classes 51200, 51300, 51400, 51500, 51900	24
51959 C	Looper Thread Nipper Spring, for styles in Classes 51200, 51500, Styles 51400 G, 51900 B, 51900 C	21
51959 D	Looper Thread Nipper Nut, for styles in Classes 51200, 51400, 51500, 51900	19
51959 E	Looper Thread Nipper Stud Spacing Collar, for styles in Classes 51300, 51500, Styles 51200 A, 51200 G, 51200 H, 51400 G	24
51959 G	Looper Thread Oil Reservoir Cover Thread Eyelet, for Style 51900 A (screw No. 87 U)	23
51959 H	Looper Thread Tension Spring, for Style 51900 A	21
51960	Parallel Take-up Thread Eyelet, front, for Styles 51900 B, 51900 C (screw No. 87 U) . .	23
51960 A	Parallel Take-up Thread Eyelet, rear, for Styles 51900 B, 51900 C (screw No. 87 U) . .	23
K52033	Presser Foot, for No. 24 gauge Style 51400 K (clamp screw No. 91)	—

LIST OF PARTS

Symbol to Order by	The figures in the last column refer only to the plates illustrating the parts and are not to be used in ordering. Refer to pink insert for prices.	Plate No.
K52034	Throat Plate, for No. 24 gauge Style 51400 K (screw No. 22570)	—
K52499	Table Board, 48" x 16" x 1 3/4", prepared completely for nonsubmerged group installations of styles in Classes 51200, 51300, 51400, 51500, 51700, 51900, 54100 without puller.	—
K52524	Presser Foot, for No. 64 gauge Style 51700 E (set screw No. 88).	—
52743 A	Looper Drive Ball Stud, for styles in Class 54100	—
52795	Main Shaft Oil Gauge Assembly, for styles in Classes 51200, 51300, 51400, 51500, 51700, 51900, 54100; one each Nos. 52895 G, 660-92, 660-93, 660-94, 660-95, 51280 K . . .	37
52804 A	Cast-off Plate, for Styles 51200 B, 51200 C, 51200 J, 51300 A, 51300 B, 51300 C, 51400 A, 51400 B, 51400 C, 51400 D, 51400 E, 51400 F, 51400 H, 51400 J, 51400 K, 51400 L, 51400 M, 51400 N, 51500 A, 51500 C, 51500 G, 51900 A (screw No. 28)	38
52818-8	Needle Holder, for Style 51500 C (thread guide No. 52842 G, thread guide screw No. 28 B, needle holder set screw No. 88, needle set screw No. 88 B)	22
52834 N	Looper Drive Ball Joint Locking Stud Nut, for styles in Classes 51300, 51400, 51500, 51700, Styles 51200 B, 51200 C, 51200 J, 51900 A	19
52841	Looper Drive Ball Joint Locking Stud, for styles in Classes 51300, 51400, 51500, 51700, Styles 51200 B, 51200 C, 51200 J, 51900 A (washer No. 8372 A, nut No. 52834 N)	25
52842 G	Needle Holder Needle Thread Guide, for Style 51500 C (screw No. 28 B).	24
52857	Cast-off Wire Support, for Styles 51200 B, 51200 C, 51200 J, 51300 A, 51300 B, 51300 C, 51300 D (screw No. 22528).	38
52857 A	Cast-off Wire Support, for styles in Class 51500	38
52882 B	Crank Chamber Cover, rear (screw No. 90).	44

LIST OF PARTS

Symbol to Order by	The figures in the last column refer only to the plates illustrating the parts and are not to be used in ordering. Refer to pink insert for prices.	Plate No.
52882 D	Crank Chamber Oil Reservoir Cover Assembly, for styles in Classes 51300, 51700, 54100, Styles 51200 B, 51200 C, 51200 J, 51400 A, 51400 B, 51400 C, 51400 D, 51400 E, 51400 F, 51400 H, 51400 J, 51400 K, 51400 L, 51400 M, 51400 N, 51900 A; one each Nos. 666-50, 35788 B (screw No. 605)	37
52882 E	Crank Chamber Oil Reservoir Gasket.	46
52883 G	Presser Bar Lifter Bracket and Guide, for machines equipped with external presser spring (screw No. 89)	34
52885 G	End Cover Hinge, front, including pin, for Style 51400 G (screw No. 22848)	27
52885 H	End Cover Hinge, rear, including pin (screw No. 22848).	27
52887	End Cover Hinge Pin No. 39132 V Presser Spring, for machines equipped with external presser spring (locating screw No. 35768 A).	44
52887 G	Presser Spring Rest, for machines equipped with external presser spring.	27
52888	Presser Bar, for machines equipped with external presser spring	35
52889	Presser Bar Bushing, upper, for machines equipped with external presser spring	26
52894 G	Oil Reservoir Cover, for styles in Classes 51300, 51500, 51700, Styles 51200 B, 51200 C, 51200 J, 51400 A, 51400 B, 51400 C, 51400 D, 51400 E, 51400 F, 51400 H, 51400 J, 51400 K, 51400 L, 51400 M, 51400 N, 51900 A (attaching screw No. 87 A).	46
52894 J	Oil Tube Brace, for styles in Classes 51300, 51500, Styles 51400 A, 51400 B, 51400 C, 51400 D, 51400 E, 51400 F, 51400 H, 51400 J, 51400 K, 51400 L, 51400 M, 51400 N, 51900 A (screw No. 22585, nut No. 41071 G).	37
52894 Y	Oil Line "T" Coupling, for inner right main shaft bearing on styles in Classes 51300, 51400, 51500, Styles 51200 B, 51200 C, 51200 J, 51700 C, 51700 D, 51700 E, 51700 G, 51700 H, 51900 A, 54100 D, 54100 E	37
52894 Z	Oil Tube, leading from oil gauge to right main bearing "T" Coupling (coupling No. 61294 X).	29
52895 G	Main Shaft Oil Gauge Frame.	—

LIST OF PARTS

Symbol to Order by	The figures in the last column refer only to the plates illustrating the parts and are not to be used in ordering. Refer to pink insert for prices.	Plate No.
52944 G	Looper Rocker Frame Sleeve, for Style 51400 G (screw No. 88 B)	40
K53133	Folder, upper, for attaching cuffs to pajamas on Style 51700 H, using strip 2 5/8 inches wide, 3/64 inch capacity.	—
K53135	Folder, upper, for attaching cuffs to pajamas on Style 51700 G using strip 2 5/8 inches wide, 1/32 inch capacity	—
53517 C-16	Folder Screw No. 93 A Needle Bar, marked "AZ-16", for No. 1 gauge Style 51500 C (set screw No. 88 A)	36
53570	Needle Thread Take-up, for Style 51400 G (screw No. 90).	38
53592	Tension Post Support, for Classes 51500, 54100, Styles 51400 A, 51400 B, 51400 C, 51400 D, 51400 E, 51400 F, 51400 H, 51400 J, 51400 K, 51400 L, 51400 M, 51400 N.	34
K53664	Pulley, working diameter 3 3/8 inches, grooved for "V" belt, for Styles 51300 A, 51300 D, 51500 A, 51500 D, 51900 B, 51900 C (spot screw No. 22597, set screw No. 22597 A).	—
K53665	Pulley, working diameter 2 1/2 inches, grooved for "V" belt, for styles in Classes 51200, 51400, 51700, 54100, Styles 51300 C, 51500 C, 51500 G, 51900 A (spot screw No. 22597, set screw No. 22597 A).	—
54101	Cloth Plate, for styles in Class 54100 (screw No. 80).	54
54105 C(12-64-12)	Feed Dog, for No. (12-64-12) gauge Styles 54100 B, 54100 C, 54100 D, 54100 E	8
54105 C(16-64-16)	Feed Dog, for No. (16-64-16) gauge	8
54108 A	Feed Dog Screw No. T22.	8
54122	Looper, marked "BC", for styles in Class 54100 (set screw No. 77).	12
	Main Shaft, left section, for styles in Class 54100	49

LIST OF PARTS

Symbol to Order by	The figures in the last column refer only to the plates illustrating the parts and are not to be used in ordering. Refer to pink insert for prices.	Plate No.
‡54122 B	Crankshaft Assembly, for styles in Class 54100; includes crankshaft No. 54122 A (bearing screw No. 75 A)	49
54124 C(12-64-12)	Throat Plate, for No. (12-64-12) gauge styles in Class 54100	4
54124 C(16-64-16)	Throat Plate, for No. (16-64-16) gauge	4
54134	Throat Plate Screw No. 87 B Feed Bar, for styles in Class 54100 (screw No. 22560 B)	43
54134 G	Feed Bar Tilting Extension (screw No. 22560 B)	43
54134 N	" " Rock Shaft	25
54135	" Dog Screw Nut, for styles in Class 54100.	19
54139	" Dog Holder, for styles in Class 54100 (screw No. 94)	27
54142	Looper Rock Shaft Bushing, for styles in Class 54100	26
54143 D	Main Oil Reservoir Cover, for styles in Class 54100 (screw No. 87 A)	46
54144	Looper Holder Frame, for styles in Class 54100	40
54145	Looper Driving Arm, for styles in Class 54100	43
54158	Needle Lever Thread Eyelet, for styles in Class 54100 (screw No. 22768).	23
54158 A	Needle Bar Thread Eyelet, for s styles in Class 54100 (screw No. 22768).	23
54180	Throat Plate Support, for styles in Class 54100 (screw No. 80).	46
54185-12	Looper Holder and Needle Guard, for No. (12-64-12) gauge styles in Class 54100 (attaching screw No. 22747, looper set screw No. 77)	27
54185-16	Looper Holder and Needle Guard, for No. (16-64-16) gauge (attaching screw No. 22747, looper set screw No. 77)	27
‡54196 A	Main Oil Reservoir, for styles in Class 54100 (screw No. 93).	52
K54381	Cast-off Plate, for Styles 51300 D, 51500 D (screw No. 28)	—

LIST OF PARTS

Symbol to Order by	The figures in the last column refer only to the plates illustrating the parts and are not to be used in ordering. Refer to pink insert for prices.	Plate No.
K54441	Looper Thread Tension Post Thread Guide, for Style 51900 A	—
K54442	Tension Post Support, for Style 51900 A . . .	—
K54450	Thread Lead-in Guide, for Style 51900 A (screw No. 94).	—
K54528	Tray, hinged body and front section, for non-submerged isolated installations of Style 51400 G without base plate No. 21680 AK . .	—
K54550	Looper Thread Guard, for Styles 51300 D, 51500 D, 51900 A (screw No. 22848).	—
K54654	Cloth Plate Cover, 7 13/32 inches long, for Style 51200 H	—
K54758	Table Top, 48" x 16" x 1 3/4", prepared completely for semisubmerged isolated group installation with "Electro Drive" of styles in Classes 51200, 51300, 51400, 51500, 51700, 51900, 54100 without puller.	—
K55001	Looper, front, for No. 18 gauge Style 51400 H (set screw No. 73).	—
K55110	Needle Thread Lubricator Oil Reservoir Bracket, for Styles 51300 D, 51500 D (screw No. 22581)	—
K55310	Folder Swinging Arm Block, 1/4 inch thick, for Styles 51700 G, 51700 H	—
K55313	Tray, hinged body and front section, for non-submerged isolated installations of Style 51400 G on base plate No. 21680 AK.	—
K55601	Cloth Plate, for Styles 51700 G, 51700 H (screw No. 80).	—
K55603	Cloth Plate, for Style 51700 F (screw No. 80)	—
61294 W	Oil Tube Coupling, for oil gauge tube and middle main bearing oil tube on styles in Classes 51300, 51400, 51500, 51700, 54100, Styles 51200 B, 51200 C, 51200 J, 51900 A	29
61294 X	Oil Tube Coupling, for main oil reservoir on styles in Classes 51300, 51400, 51500, 51700, 54100, Styles 51200 B, 51200 C, 51200 J, 51900 A.	29
92201	Regulating Screw, for presser roller hand lifter lever on Style 51400 G (nut No. 12982).	17

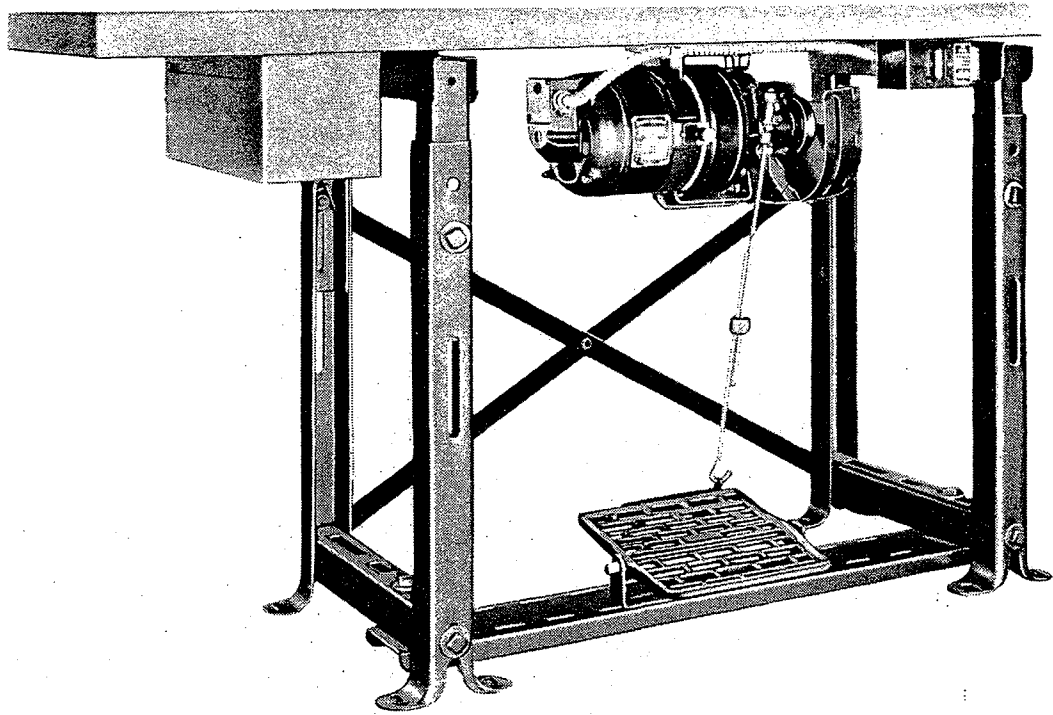

"Electro Drive"

Table Top, drawer, stand, and treadle are shown only
for clarity, and are furnished separately.

PRICE LIST FOR CATALOG NO. 77 L
PARTS
(Effective March 1, 1938)

Postage and insurance will be charged on all goods sent by mail.
Prices are subject to change without notice. TERMS, NET CASH.

Part No.	Price Per Part	Part No.	Price Per Part	Part No.	Price Per Part
T2	\$0.19	93	\$0.07	431 A	\$0.26
WA15	15.45	93 A	.07	432	.06
16	.42	94	.07	433	.16
18	.16	95	.05	434	.16
OI-19	1.35	96	.05	482	.32
20	.03	96 A	.05	Y500-257	9.50
22 I	1.90	97	.07	Y502-319	11.00
T22	.07	97 A	.07	Y503-319	9.50
24	.37	98	.05	Y505-407	12.00
24 X	.32	98 A	.07	Y506-530	15.00
25	.28	100 B	.13	531	.06
25 B	.06	107	.08	538	.07
25 C	.09	108	.05	539	.19
25 S	.12	109	.07	604	.06
25 T	.19	109 B	.07	605	.06
25 CC	.07	110-3	.06	605 A	.06
28	.06	112	1.45	627	.16
28 B	.05	116	.16	650-28	.04
28 C	.05	116 A	.08	650-40	.05
36 G	.19	118 B	.21	650 A-16	.04
J42 JK	.19	V118	1.65	650 A-18	.04
43	.65	134	.17	650 A-20	.04
43 C	.75	136	.08	650 B-26	.05
50 J-16	.07	137	.19	650 X-18	.03
50 J-26	.07	138	.06	650 X-22	.03
52 A	.19	158 A	.26	650 X-32	.03
54	1.05	158 B	.23	651 D-24	.04
TA54	5.25	161	.21	652-16	.01
TA55	65.00	166	.12	652-20	.01
56	.32	187 A	.06	652-24	.01
57 WB	.07	187 B	.11	652 C-9	.03
57 WC	.03	188 D	.19	660-73	3.40
57 WD	.05	195 X	2.35	660-74	.11
HA61 D	.05	195 Y-6	2.65	660-75	.11
64 A	.37	197 X	2.10	660-81	.21
64 B	.16	197 Y	2.10	660-84	.12
65 A	2.40	198 B-6	4.20	660-85	.07
65 XD	.37	198 X	2.90	660-90	.02
69 S	.10	198 XA	1.85	660-92	.02
69 FD	.03	199	.16	660-93	.02
73	.09	199 A	.23	660-94	.16
73 A	.06	201 A	.85	660-95	.16
75 A	.06	201 C	.19	660-104	.47
77	.07	226	.06	660-107	.19
78	.05	243	.19	660-112	.11
79	.07	258 A	.21	660-136	.95
80	.08	269	.16	660-138	.95
81	.05	357	.07	660-143	.05
86	.09	380	.06	660-148	.21
86 X	.12	402	.11	660-152	.47
87	.07	413	.19	660-159	.65
87 A	.07	420	.37	666-13	.11
87 B	.07	420 C	.60	666-16	.11
87 U	.05	421	.21	666-19	.02
88	.05	421 C-10	.13	666-28	.16
88 A	.07	422	.32	666-49	.10
88 B	.05	423	.21	666-50	.13
89	.06	424	.03	666-66	.05
90	.07	426	.13	666-73	.42
91	.07	430 A	.42	666-74	.47
91 A	.06	430 B	.42	667 D-16	.12
91 D	.07	430 C	.42	668-5	.04

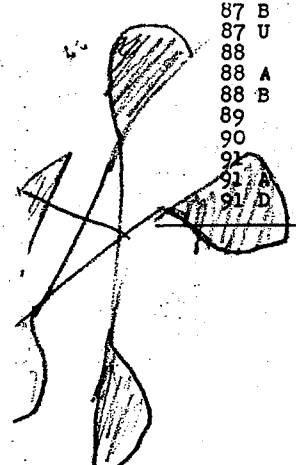

Copyright, 1938, by
UNION SPECIAL MACHINE COMPANY
Chicago, U.S.A.
Rights Reserved In All Countries Printed in U.S.A.

PRICE LIST FOR CATALOG NO. 77 L
PARTS
(Effective March 1, 1938)

Part No.	Price Per Part	Part No.	Price Per Part	Part No.	Price Per Part
668-6	\$0.04	8040	\$0.13	21113 B	\$0.26
668-7	.05	8118-64	2.20	21130 A-2	.80
668-12	.02	8372 A	.11	21130 A-4	1.35
668-13	.02	9224 E	1.45	21130 A-6	1.80
719	.05	9255	.11	21145	.11
751	.16	9271	.45	21157	.55
753	.32	9634	.15	21161 C	1.80
Y802	2.75	9634 A	.21	21161 D	.26
1096 B	.05	9705	2.30	21163	.21
1248	.02	9720	11.55	21164	1.15
1280	.16	9724	3.15	21169 E	1.70
1286	.42	9733	2.90	21169 F	1.70
1286 A	.32	9735	1.25	21172 E	1.25
1286 B	.07	9939 F	1.15	21172 F	1.70
HA1286	.48	11534	.16	21172 J	2.35
1287	.65	11635 B	.32	21172 K	1.35
1288	.47	11638 M	.16	21172 L	.85
1332	.19	12538	.21	21172 M	2.95
1346	.26	12935 A	.06	21172 N	.26
1349 A-5	.13	12957 E	.08	21173 A	.65
1361 A	.04	12964 C	.02	21173 B	.80
1740	.02	12982	.16	21178	.55
4761	.42	12986 B	.12	21182 K	1.05
6042 A	.11	12987 A	.16	21182 L	.65
6405 M	2.20	12988 A	.11	21182 N	3.80
6405 U	3.70	14077	.16	21182 P	.80
6405 W	2.20	14090	.05	21182 T	4.20
6420 W	3.40	14786 A	.05	21192 R	.05
6424 W	2.10	15430 C	.19	21201	.37
6428 L	4.75	15430 D	.19	21202	.47
7005 A-4 1/2	2.30	15438 D	.12	21203	.65
7005 A-6	2.45	15465 F	.95	21204	.65
7018 E-5	1.45	16134 K(12-64-12)	16.80	21205 A	.47
7018 E-5 1/2	1.45	16134 K(16-64-16)	16.80	21207	.11
7018 E-6	1.45	16152-56	2.20	21208	2.35
7020 B-4 1/2	3.05	16152-72	2.20	21210	.05
7020 B-5	3.05	16152-80	2.20	21210 A	.05
7024 C-4 1/2	3.15	16152-88	2.20	21211	.05
7024 C-5	3.15	16152-96	2.50	21218	.55
7040-6	.11	16152-112	2.50	21225-1/8	.42
7040-48	.19	16152-128	3.15	21225-5/32	.42
7040-61	.19	16154(12-64-12)	4.75	21227 R	23.50
7403 P	1.10	16154(16-64-16)	4.75	21227 AC	23.50
7405 B-6	1.95	16164	.15	21227 HH	2.00
7405 U-4 1/2	2.30	16182 B	.85	21231 D	24.50
7405 AF-5 1/2	3.40	16182 C	.85	21233 D	4.20
7405 AG-5	2.10	16184 A-4(12-64-12)	2.10	21236	2.00
7420 AG-4 1/2	3.35	16184 A-4(16-64-16)	2.10	21260	1.05
7420 AG-5	3.35	16194	.13	21260 A	1.05
7420 AG-5 1/2	3.35	16194 B	.65	21260 B	1.05
7424 B-6	2.85	16197-2-16	.47	21260 C	1.05
7424 AF-5 1/2	4.75	16241	.13	21260 D	.95
7424 AG-5	3.40	16241 A	.16	21260 E	1.30
7459 A	.05	16505-88	4.40	21261	1.35
7475 Q	2.00	16524 B-88	5.80	21262	.42
7476 P	1.35	16527 B-88		21262 G-340	.73
7479 P	.65	16638 D	.11	21262 G-350	.75
7481 P	1.85	21104 A	.47	21262 G-370	.78
7482 P	2.50	21104 B-2	.11	21262 G-380	.80
7485 P	.60	21104 B-11	.21	21300 C-5 3/4	.15
7486 P	2.20	21104 B-14	.26	21350	.02
7486 PA	.15	21104 B-20	.37	per C \$1.30	
7487 Q	.65	21104 C	.37	21351	.01
7489 P	.09	21104 D	.55	per box (500) \$.55	
7490 P	4.75	21104 E	.16	21355	.11
7491 P	4.50	21104 F	.08	21371 Q	1.30
7528 H-4 1/2	3.70	21104 G	.11	21371 BR-42	5.70
7827 A-6	3.45	21104 H	.05	21371 BR-48	5.95
7933-48	.42	21104 K	.11	21371 BR-54	6.55
7933-61	.42	21105 J	.05	21371 BR-60	7.20
7947	.16	21113 A	.06	21371 BS-48	6.95

PRICE LIST FOR CATALOG NO. 77 L
PARTS
(Effective March 1, 1938)

Part No.	Price Per Part	Part No.	Price Per Part	Part No.	Price Per Part
21371 BS-54	\$7.55	21698-6	\$1.75	22769	\$0.08
21371 BS-60	8.20	21701 A	12.60	22773	.25
21371 BT-42	4.75	21708	.75	22787 B	.16
21371 BT-48	5.00	21708 B	.37	22788	.28
21371 BT-54	5.60	21723 C	1.45	22794 B	.13
21371 BT-60	6.25	21724 A	.06	22795	.16
21371 CT	.11	21725	.18	22797	.08
21371 CX-48	7.20	22504	.12	22799	.08
21371 CX-54	7.30	22507	.02	22799 B	.05
21371 CX-60	7.90	22508	.02	22799 C	.05
21371 FQ-42	5.25	22509	.02	22799 D	.05
21371 FQ-48	5.50	22513	.07	22799 E	.05
21371 FQ-54	6.10	22514	.12	22799 L	.08
21371 FQ-60	6.75	22515	.16	22799 N	.08
21371 FR-42	6.00	22517	.07	22801	.08
21371 FR-48	6.25	22519	.12	22813	.04
21371 FR-54	6.85	22521	.13	22823 A	.16
21371 FR-60	7.50	22524	.07	22823 B	.16
21371 GT-48	7.50	22525	.07	22824 A	.05
21373 A-5	75.00	22528	.07	22829	.05
21373 A-5D	75.00	22532	.16	22833	.07
21373 A-7	75.00	22539 C	.16	22834	.08
21373 A-7B	75.00	22542	.13	22835	.11
21373 A-7D	75.00	22547 A	.06	22837	.11
21373 A-8	80.00	22548	.12	22839	.07
21373 A-8A	80.00	22557	.19	22840	.16
21375 AA	1.80	22559 A	.07	22840 A	.11
21375 AH	1.60	22559 B	.07	22840 B	.16
21377 AH	4.05	22559 C	.07	22845 A	.13
21377 AJ	4.05	22560	.05	22848	.05
21377 AK	4.05	22560 A	.05	22849	.05
21377 AL	4.05	22560 B	.05	22863	.07
21377 AP	7.35	22561	.05	22863 A	.37
21377 AS	5.75	22565 C	.05	22864	.07
21385 B	.70	22566 A	.37	22866	.07
21388	.21	22569	.07	22874	.11
21388 N	.21	22570	.07	23100	9.45
21388 R	.21	22571	.05	23151 A	6.90
21388 X	5.50	22571 A	.11	23160	1.20
21388 Z	1.50	22580	.05	23168 N	27.50
21388 AE	2.55	22581	.13	23168 P	27.50
21394	7.35	22585	.05	23168 Q	17.50
21394 G	.80	22585 B	.07	23184 E	4.40
21394 H	1.05	22586 B	.05	23184 G	1.35
21394 K	7.35	22587	.08	23184 K	14.75
21396 C	5.25	22593	.06	23184 L	6.60
21396 AG	.05	22594	.07	23184 M	1.70
21396 AL	.42	22596	.07	23215 BC-5/8	5.00
21396 AP	.32	22597	.05	23215 BC-3/4	5.00
21657-1	1.85	22597 A	.05	23215 BC-7/8	5.00
21657-2	1.85	22598 C	.13	23229 M	3.15
21657-3	1.85	22599	.06	23229 N	1.10
21657-4	2.00	22632 F-24	.03	23229 P	.55
21657 A	.75	22637 D	.17	23229 Q	.95
21657 B	1.35	22704	.06	23322 AB-3/4	10.50
21657 C	.75	22711	.13	23322 AB-7/8	10.50
21657 D	.37	22716	.07	23322 AB-1	10.50
21657 E	.04	22716 A	.01	23322 AB-1 1/8	10.50
21660 A	5.45	22726	.17	23322 AB-1 1/4	10.50
21661	.32	22726 A	.05	23322 AC	.90
21662	.95	22729	.07	23324 G	.80
21663	.32	22730	.09	23324 H	1.05
21663 A	.32	22735	.17	23324 J	.65
21664	.21	22743	.05	23324 R	1.30
21665	.21	22747	.08	23324 U	1.40
21677	.42	22752	.05	23324 V	.95
21680 AK	3.15	22752 A	.07	23360 C-1 1/2	47.00
21697 C	2.50	22752 B	.11	23360 F-1/2	19.00
21698-2	.90	22757	.07	23386 E-7/16	27.50
21698-4	1.30	22764 A	.05	23386 E-15/32	27.50
21698-5	1.50	22768	.05	23386 E-1/2	27.50

PRICE LIST FOR CATALOG NO. 77 L
PARTS
(Effective March 1, 1938)

Part No.	Price Per Part	Part No.	Price Per Part	Part No.	Price Per Part
23386 E-9/16	\$27.50	23449 B		41258	\$0.32
23386 E-19/32	27.50	23449 C		41258 A	.11
23386 E-5/8	27.50	28604	\$0.80	41258 B	2.65
23386 F	2.85	28606-1/2	.21	41258 D	7.35
23386 G	.30	28606-1	.37	41258 E	2.65
23386 H	.40	28619	.02	41258 CG	1.05
23386 J	.25	28705	*35.00	43220 F	5.15
23401 J-56	20.00	28705 D	*35.00	43230 H	1.85
23401 K-48	20.00	28707 B	*32.00	43230 J	1.60
23401 K-56	20.00	28707 D	*35.00	43266	.16
23401 K-64	20.00	28708	*37.00	43294 A	.75
23402 D	1.60	28708 A	*37.00	43294 D	.37
23403-48	1.60	29066 F	3.40	43297	.37
23403-56	1.60	29105 A	9.20	43297 A	.21
23403-64	1.60	29105 B	9.20	43443 Q	.05
23404 B	.90	29105 L	11.40	K48039	2.10
23404 E	1.60	29105 M	11.40	K48964	7.00
23405 J	5.25	29105 N	11.40	K49039	11.00
23405 L	5.00	29138 H	4.05	K49157	17.50
23405 N	7.50	29138 J	4.05	K49290	9.50
23406 B-7/8	13.00	29138 K	4.05	K49640	25.00
23406 C-1 5/8	16.80	29138 L	4.05	K49746	25.00
23406 D-1 1/2	16.80	29138 M	6.30	K49992	1.85
23421 U-6-1/32	2.90	29192	5.50	K49995	7.25
23421 U-8-1/32	2.90	29192 A	5.80	K50068	1.95
23421 U-8-1/16	2.90	29192 B	7.50	K50176	8.40
23421 U-10-1/32	2.90	29192 C	5.50	K50177	.80
23421 U-10-1/16	2.90	29192 D	5.80	K50370	6.00
23421 U-12-1/32	2.90	29202 A-1	4.85	K50410	27.00
23421 U-12-1/16	2.90	29202 G-1	5.50	K50909	7.25
23421 U-12-3/32	2.90	29402	.75	K50911	8.25
23421 U-16-1/16	2.90	29481 C	5.80	K50912	2.10
23421 U-16-3/32	2.90	29730 A	7.90	51134	4.35
23421 U-16-1/8	2.90	35731 A	.32	51134 A	4.35
23421 U-18-1/16	2.90	35733 B	.21	51134 G	1.15
23421 U-18-3/32	2.90	35759	.70	51142	.75
23421 U-18-1/8	2.90	35768 A	.16	51147	.42
23421 U-26-1/16	2.90	35788 B	.26	K51165	3.00
23421 V-8-1/32	2.90	35818 N-8	2.35	51170 B	.70
23421 V-10-1/32	2.90	35818 N-9	2.35	51170 C	.16
23421 V-12-1/32	2.90	35820 P-8	6.30	51170 D	.04
23421 V-16-1/32	2.90	35820 P-9	6.30	51201	4.95
23422 U-1/32	2.35	35820 R-9	21.00	51201 A	4.95
23422 U-1/16	2.35	35830	1.85	51201 B	5.25
23422 U-3/32	2.35	35830 B	2.60	51202	1.25
23422 U-1/8	2.35	35830 C	4.45	51205 A	2.65
23422 V-1/32	2.35	35830 D	.16	51208	3.00
23425 T	.32	35830 E	2.20	51208 D	3.00
23425 U	.37	35830 F	.32	51213	2.35
23432 A	2.50	35830 G	3.95	51215 A	4.85
23435-32	10.00	35830 H	.16	51215 B	5.05
23435-48	10.00	35830 K	.16	51216	.55
23435-64	10.00	35830 P-8	3.95	51216 A	1.70
23436	2.10	35830 P-9	3.95	51217	1.85
23437 A	1.60	35830 R-9	6.85	51220 A	3.40
23437 B	1.30	35831 A	.42	51220 J	16.90
23438 A		35833 A	.19	51221	3.25
23438 B	.50	35833 C	.37	51222	4.20
23439 A	2.60	38208 G-26	4.20	51222 B	12.35
23447-64	13.65	38209 A	4.20	51224 A	3.70
23447-72	13.65	39132 V	.21	51224 B	3.70
23447-80	13.65	39135	.37	51225	2.35
23447 A	.32	39141 G	.19	51235	2.65
23447 B	.95	39193	.90	51235 A	1.70
23447 C	.21	39193 A	.25	51235 B	.80
23448-64	1.85	39193 B	.37	51236	2.65
23448-72	1.85	39236 A	.16	51236 A	.32
23448-80	1.85	K40881	25.00	51236 B	.19
23449	13.50	41047	.26	51236 C	.47
23449 A		41071 G	.16	51240 A	.16

*F.O.B. New York City, Prices F.O.B. other points on application

PRICE LIST FOR CATALOG NO. 77 L
PARTS
(Effective March 1, 1938)

Part No.	Price Per Part	Part No.	Price Per Part	Part No.	Price Per Part
51241	\$5.80	51292 C	\$0.16	51418 K-26	\$2.35
51241 D	2.35	51292 D	.55	51420-6	4.45
51242 A	1.30	51292 E	.55	51420-8	4.45
51242 C	.55	51292 F-1	.06	51420-10	4.45
51242 E	2.85	51292 F-2	.06	51420-12	4.45
51242 F	.13	51292 F-4	.06	51420-16	4.45
51243 B	1.30	51292 F-5	.06	51420-18	4.45
51243 C	.42	51292 F-8	.06	51420 C-32	9.45
51243 E	.21	51292 F-14	.09	51420 C-48	9.45
51243 J	2.35	51293	3.70	51420 E-8	4.85
51243 K	.75	51293 A	.26	51420 E-10	4.85
51243 L	.05	51293 B	.13	51420 E-12	4.85
51243 N	.10	51293 K	.40	51420 E-16	4.85
51243 R	.21	51293 L	.42	51420 M-48	25.00
51244	1.85	51294 A	.37	51422 B	12.35
51244 A	1.30	51295	.13	51423	3.15
51244 B	1.70	51296	.02	51423 B	2.65
51244 C	.70	51296 A	.02	51424-16	3.15
51244 E	.55	51301 A	5.25	51424-18	3.15
51245	2.65	51305 A	2.35	51424 A-6	3.15
51245 A	.16	51305 B	2.35	51424 A-8	3.15
51246	.07	51320 B	3.40	51424 A-10	3.15
51250	2.95	51320 C	4.25	51424 A-12	3.15
51250 B	.60	51321 A	3.70	51424 B-32	6.05
51250 C	.04	51322 B	12.35	51424 B-48	6.05
51251	1.85	51324 B	2.35	51424 C-48	5.00
51252	1.80	51330 B	2.35	51424 E-8	5.00
51254	.90	51330 C	3.00	51424 E-10	5.00
51254 A	.80	51394	6.85	51424 E-12	5.00
51256 A	.55	K51396	6.00	51424 E-16	5.00
51256 B	.75	51401	6.85	51424 F-32	5.50
51257 A	1.35	51401 C	2.65	51424 K-26	3.15
51257 C	.80	51401 H	7.15	51425	2.35
51258	.26	51402	1.25	51428-8	4.45
51258 A	.26	51404	.80	51428-10	4.45
51260	.55	51405-8	2.65	51428-12	4.45
51260 A	.55	51405-16	2.65	51430	2.65
51270 A	.37	51405 A-8	2.65	51430 A-6	3.15
51270 B	.37	51405 A-10	2.65	51430 A-8	3.15
51280 A	1.60	51405 B-32	4.75	51430 A-10	3.15
51280 B	1.75	51405 B-48	4.75	51430 A-12	3.15
51280 G	1.75	51405 C-48	4.75	51430 A-16	3.15
51280 K	.03	51405 E-8	2.65	51430 A-18	3.15
51281-204	1.60	51405 E-16	2.65	51430 B	1.85
51281-206	1.60	51405 F-32	4.75	51430 C-32	6.30
51281-216	1.60	51405 K-26	3.80	51430 C-48	6.30
51281-226	1.60	51408-6	3.00	51430 D	1.85
51281-228	1.60	51408-8	3.00	51430 E-8	3.40
51281-230	1.60	51408-10	3.00	51430 E-10	3.40
51281-232	1.60	51408-12	3.00	51430 E-12	3.40
51281-233	1.60	51408-16	3.00	51430 E-16	3.40
51281 C-226	1.85	51408-18	3.00	51430 F	.08
51281 F	.26	51408-24	3.70	51430 G	
51282	.47	51408-26	3.70	51430 H	
51282 B	.60	51408-32	3.70	51430 K-26	
51282 C	1.15	51408-48	3.70	51430 M-48	
51282 H	.05	51408 A-16		51430 N-48	
51282 J	4.50	51409	3.00	51443 G	3.15
51283	2.10	51409 B	3.00	51457	3.70
51283 A	.05	51413	2.90	51458	.32
51283 B	.03	51417-6	2.85	51458 A	.32
51283 C	.80	51417-8	2.85	51459 A	1.10
51290	.55	51417-10	2.85	51460	.55
51290 A	.65	51417-12	2.85	51460 A	.65
51290 D	.55	51417-16	2.85	51461	.55
51290 E	.65	51417-18	2.85	51461 A	1.60
51290 N	3.15	51417 B	2.85	51461 B	.42
51291	.55	51418-16	1.15	51461 C	.16
51292	.26	51418 B-32	2.35	51462	1.30
51292 A	.16	51418 B-48	2.35		
		51418 K-24	2.35		

PRICE LIST FOR CATALOG NO. 77 L
PARTS
(Effective March 1, 1938)

Part No.	Price Per Part	Part No.	Price Per Part	Part No.	Price Per Part
51462 A	\$0.19	51720 D-56	\$10.50	51773	\$0.37
51462 B	.70	51720 D-64	10.50	51774-64	3.80
51462 C	.26	51720 D-72	11.55	51774-72	3.80
51477	5.65	51720 D-80	11.55	51774-80	3.80
51480	1.95	51720 D-96	12.60	51774 D	1.95
51482 A	.75	51720 D-112	12.60	51774 H	1.05
51482 B	3.45	51720 E-72	17.85	51774 L	3.10
51491	.30	51720 E-80	17.85	51774 N	1.35
51491 A	.70	51724-56	5.00	51774 P	.60
51491 B-4	2.65	51724-64	5.00	51774 T	.35
51492	.26	51724-72	5.50	51775	1.05
51494	6.30	51724-80	5.50	51775 A	.35
51505-18	3.95	51724-96	6.05	51776	4.75
51505 C-1	3.80	51724-112		51777-72	2.00
51505 G-1	3.80	51724 D-56	5.50	51777-80	2.00
51508-16	3.00	51724 D-64	5.50	51777 D	1.45
51508-18	3.00	51724 D-72	6.05	51777 H	1.05
51508 C-1	3.90	51724 D-80	6.05	51777 L	3.15
51508 G-1	3.90	51724 D-96	6.55	51785	.10
51509 C	3.90	51724 D-112		51905-5	3.95
51513	3.50	51724 E-64	7.60	51905-7	3.95
51517-16	2.85	51724 E-72	7.60	51905 A-7	3.95
51517 A	2.85	51724 E-80	7.60	51905 B-9	3.95
51517 G-1	2.85	51725	2.65	51905 C-9	4.75
51518 G-1	2.65	51725 A	2.65	51908-5	3.00
51520-16	5.80	51725 E	2.65	51908-6	3.00
51520-18	5.80	51730-56	7.60	51908-7	3.00
51520 C-1	8.40	51730-64	7.60	51908 A-7	3.00
51523 C	2.65	51730-72	8.65	51908 A-8	3.00
51524-16	3.15	51730-80	8.65	51908 A-9	3.00
51524-18	3.15	51730-96	9.70	51909-5	3.00
51524 C-1	4.10	51730-112	9.70	51909-6	3.00
51524 G-1	4.10	51730 A-56	.80	51909-7	3.00
51525	2.35	51730 A-64	.80	51909 A-7	3.00
51525 C	2.35	51730 A-72	.95	51909 A-8	3.00
51525 G	2.35	51730 A-80	.95	51909 A-9	3.00
51530-16	3.90	51730 A-96	1.05	51909 B	3.00
51530-18	3.90	51730 A-112	1.05	51913	4.45
51530 A	1.85	51730 D-56	7.60	51917-5	2.85
51530 C-1	3.35	51730 D-64	7.60	51917-9	2.85
51530 D	2.65	51730 D-72		51918-5	2.35
51530 E	1.05	51730 D-80		51918-6	2.35
51530 F	.65	51730 D-96		51918-7	2.35
51530 G	.11	51730 D-112		51920-5	6.85
51701 C	5.25	51730 E-72		51920-6	6.85
51701 F	6.00	51730 E-80		51920-7	6.85
51705-56	4.75	51730 F-72		51924-5	6.30
51705-64	4.75	51730 F-80		51924-7	6.30
51705-72	5.25	51741	2.35	51924 A-6	6.30
51705-80	5.25	51741 B	2.35	51924 A-7	6.30
51705-96	5.80	51743 B	6.85	51924 B-8	6.30
51705-112	5.80	51743 F	6.85	51924 B-9	6.30
51705 D-56	4.75	51743 G	.60	51924 C-9	8.00
51705 D-64	4.75	51744	2.35	51925	2.65
51705 D-72	5.25	51744 A	2.65	51930	.04
51705 D-80	5.25	51745	1.60	51930 A	2.35
51705 D-96	5.80	51751	1.85	51930 B-5	3.70
51705 D-112	5.80	51758	.26	51930 B-6	3.70
51705 E-64	5.25	51758 A	.26	51930 B-7	3.70
51705 E-72	5.25	51759	.80	51957	1.15
51705 E-80	5.25	51770-56	1.60	51958	.37
51708	3.00	51770-64	1.60	51958 A	.37
51709	3.00	51770-72	2.10	51958 B	.70
51713	2.35	51770-80	2.10	51959	1.15
51717	2.35	51770-96	2.65	51959 B	.16
51720-56	11.55	51770-112	2.65	51959 C	.03
51720-64	11.55	51771	.21	51959 D	.05
51720-72	12.60	51772-56	.16	51959 E	.02
51720-80	12.60	51772-64	.16	51959 G	1.15
51720-96	13.65	51772-72	.26	51959 H	.06
51720-112	13.65	51772-80	.26	51960	.80

PRICE LIST FOR CATALOG NO. 77 L
PARTS
(Effective March 1, 1938)

Part No.	Price Per Part	Part No.	Price Per Part	Part No.	Price Per Part
51960 A	\$0.95	52894 Y	\$0.47	54144	\$2.85
K52033	7.75	52894 Z	.37	54145	2.90
K52034	5.50	52895 G	1.05	54158	.40
K52499	5.50	52944 G	.95	54158 A	.37
K52524	18.00	K53133	25.00	54180	1.75
52743 A	1.30	K53135	25.00	54185-12	4.20
52795	2.00	53517 C-16	2.85	54185-16	4.20
52804 A	1.25	53570	.95	54196 A	6.85
52818-8	1.60	53592	.65	K54381	2.00
52834 N	.19	K53664	4.40	K54441	1.90
52841	.32	K53665	4.50	K54442	1.35
52842 G	.11	54101	5.25	K54450	4.50
52857	3.70	54105 C(12-64-12)	7.05	K54528	5.25
52857 A	3.70	54105 C(16-64-16)	7.05	K54550	.95
52882 B	.45	54108 A	2.75	K54654	
52882 D	.50	54122	4.20	K54758	6.35
52882 E	.10	54122 B	13.85	K55001	
52883 G	2.65	54124 C(12-64-12)	9.45	K55110	1.75
52885 G	.65	54124 C(16-64-16)	9.45	K55310	.90
52885 H	.65	54134	4.10	K55313	5.85
52887	1.60	54134 G	3.15	K55601	7.30
52887 G	.32	54134 N	.65	K55603	7.30
52888	1.35	54135	.21	61294 W	.16
52889	.65	54139	3.70	61294 X	.11
52894 G	.95	54142	.80	92201	.18
52894 J	.11	54143 D	1.05		

NEEDLES

Type No.	Size No.	Quan.	Price	Type No.	Size No.	Quan.	Price
101	019, 022, 025, 027, 029, 032, 034, 036, 038, 040, 042, 044, 046, 049, 054	25	\$0.70	109	027, 032, 036, 040, 044	25	\$0.77
		100	2.00			100	2.20
		500	10.00			500	11.00
		1000	19.00			1000	20.90
101 G	032 036 040	25	.81	109 B	027, 032, 036, 040, 044, 049	25	.77
		100	2.30			100	2.20
		500	11.50			500	11.00
		1000	21.85			1000	20.90
106	027, 029, 032, 036, 038, 040, 042, 044, 049	25	.77	110	036 040 044	25	.81
		100	2.20			100	2.30
		500	11.00			500	11.50
		1000	20.90			1000	21.85
106 A	032 036	25	.77	110 G	040	25	.91
		100	2.20			100	2.60
		500	11.00			500	13.00
		1000	20.90			1000	24.70
106 G	032 036 040 044	25	.88	121	019, 022, 025, 027, 029, 032, 036, 038, 040, 042, 044, 049, 054	25	.70
		100	2.50			100	2.00
		500	12.50			500	10.00
		1000	23.75			1000	19.00
108	032, 036, 038, 040, 042, 044, 049, 054	25	.81	121 G	032 036 040 049	25	.81
		100	2.30			100	2.30
		500	11.50			500	11.50
		1000	21.85			1000	21.85
108 G	040 044 049 054	25	.91	124	040, 044, 049, 060, 067, 080, 090	25	.74
		100	2.60			100	2.10
		500	13.00			500	10.50
		1000	24.70			1000	19.95
				5000	95.00		

PRICE LIST FOR CATALOG NO. 77 L
NEEDLES
(Effective March 1, 1938)

Type No.	Size No.	Quan.	Price	Type No.	Size No.	Quan.	Price
126	027, 032,	25	\$0.77	143	120	25	\$1.09
	036, 040,	100	2.20			100	3.10
	042, 044,	500	11.00			500	15.50
	049, 054	1000	20.90			1000	29.45
128	032, 036, 040,	25	.81	143	140	25	1.33
	044, 049, 054,	100	2.30			100	3.80
	060, 067, 080	500	11.50			500	19.00
		1000	21.85			1000	36.10
128 F	044	25	.81	143 G	067	25	.84
	049	100	2.30			100	2.40
	054	500	11.50			500	12.00
		1000	21.85			1000	22.80
128 G	044	25	.91	143 G	090	25	.95
	049	100	2.60			100	2.70
	054	500	13.00			500	13.50
		1000	24.70			1000	25.65
128 GA	040	25	.91	144	067 080	25	.84
	044	100	2.60			100	2.40
	049	500	13.00			500	12.00
	054	1000	24.70			1000	22.80
129	027, 029,	25	.70	144	090	25	.91
	032, 036,	100	2.00			100	2.60
	040, 044,	500	10.00			500	13.00
	049	1000	19.00			1000	24.70
130	036, 040,	25	.81	147 G	049 054	25	.91
	044, 049,	100	2.30			100	2.60
	054, 060	500	11.50			500	13.00
		1000	21.85			1000	24.70
130 G	044	25	.91	302	032, 036, 040, 042, 044, 049	25	.81
	049	100	2.60			100	2.30
	054	500	13.00			500	11.50
		1000	24.70			1000	21.85
140	027, 032,	25	.70	907	027, 032, 034, 036, 040, 042, 044, 049, 054	25	.88
	036, 040,	100	2.00			100	2.50
	044, 049,	500	10.00			500	12.50
	054, 060	1000	19.00			1000	23.75
143	054	25	.74	929	044, 049, 054, 060, 067, 080	25	.91
	060	100	2.10			100	2.60
	067	500	10.50			500	13.00
	080	1000	19.95			1000	24.70
		5000	95.00				
143	090	25	.84	943	067 073 080	25	1.05
		100	2.40			100	3.00
		500	12.00			500	15.00
		1000	22.80			1000	28.50
143	100	25	.98	943 G	073 080	25	1.16
		100	2.80			100	3.30
		500	14.00			500	16.50
		1000	26.60			1000	31.35

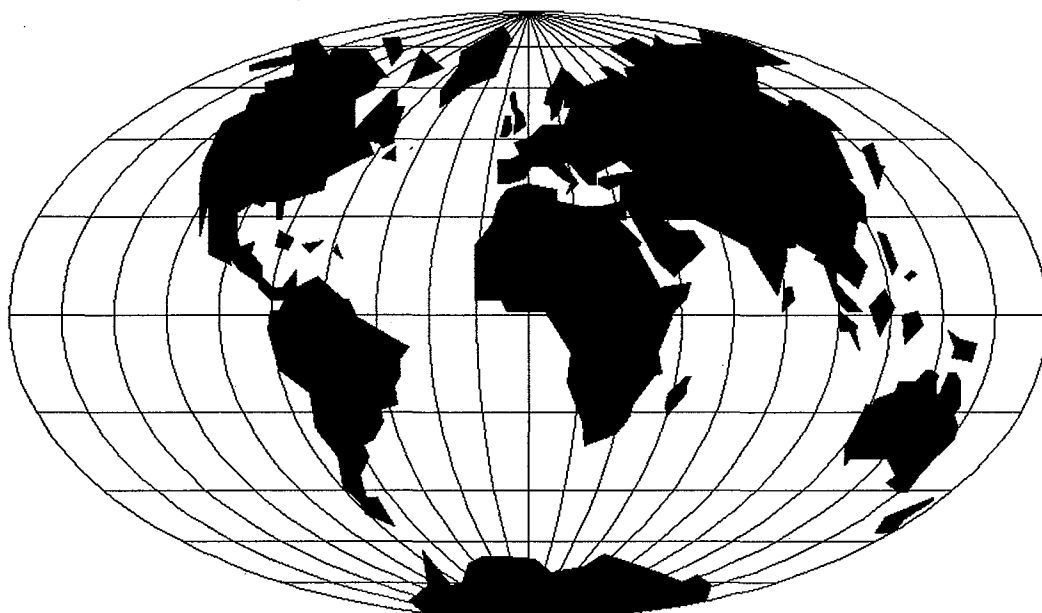

WORLDWIDE SALES AND SERVICE

Union Special Corporation maintains sales and service facilities throughout the world. These offices will aid you in the selection of the right sewing equipment for your particular operation. Union Special Corporation representatives and service technicians are factory trained and are able to serve your needs promptly and efficiently. Whatever your location, there is a qualified representative to serve you.

Corporate Office: One Union Special Plaza
Huntley, IL 60142
Phone: 708•669•5101
Fax: 708•669•1096

European Distribution Center: Union Special GmbH
Raiffeisenstrasse 3
D-71696 Möglingen, Germany
Tel: 49•07141•247•0
Fax: 49•7141•247•100

Brussels, Belgium
Charlotte, N.C.
Commerce, CA
El Paso, TX
Hong Kong, China
Huntley, IL
Leicester, England
Lille, France
Miami, FL
Milan, Italy
Mission, TX
Möglingen, Germany
Montreal, Quebec
Osaka, Japan

Other Representatives throughout
all parts of the world.



Union Special
INDUSTRIAL SEWING EQUIPMENT